

电力工业电气设备质量检验检测中心

Quality Inspection and Test Center
for Equipment of Electric Power



(3) 检字

JHG564 号

检测报告

Inspection Report



地 址： 湖北省武汉市洪山区珞喻路 143 号
邮 编： 430074
电 话： 4006565689
传 真： (027) 59832255
网 址： China-qitc.sgepri.sgcc.com.cn

Quality Inspection and Test Center for Equipment of Electric Power Inspection Report

2013.JG564

1. Client

Guangdong Sihui Instrument Transformer Works Co., Ltd

2. Description of Sample

Name of test sample: Inductive voltage transformer

Type: JSQXF-145K

Sample NO.: V1310132060

Manufacturer: Guangdong Sihui Instrument Transformer Works Co., Ltd

Date of Manufacture: October-2013

Sampling way: offer by client

3. Inspection Standards/References

GB1207-2006 Inductive voltage transformers

IEC60044-2:2003 Instrument transformers -Part 2: Inductive voltage transformers

DL/T726-2000 Specification of voltage transformer for electrical power for order

4. Category of Inspection

Routine Test /Type Test

5. Inspection Dates:

2013 - 10 - 29 ~ 2013 - 11 - 12

6. Conclusion:

Inductive voltage transformer with the type of JSQXF-145K offered by Guangdong Sihui Instrument Transformer Works Co., Ltd meets the requirements of the corresponding items of the standards GB1207-2006, etc.

7. Valid time : 5 years

Note: This English report is written at request of the client. In the event of any difference in meanings of the text, the Chinese report shall take precedence over the English version.

Inspected by:

王焱 刁德锋

Checked by:

郭之勤

Examined and verified by:

谷华

Approved by:

黄晓

Date:

2013-12-07

8. Testing Item and Conclusion

No.	Item	Reference standard	Test result	Conclusion
1	Inspection semblance	The nameplate, sign, earthing terminal, terminal markings shall meet the requirements.	OK	Pass
2	Power-frequency withstand test on secondary windings	Applied voltage on winding-to-winding and winding-to-earth shall be 3kV/50Hz/1min	Test voltage 3kV/50Hz/1min No disruptive puncture occurs.	Pass
3	Power frequency withstand test on earthed terminal of primary winding	Applied voltage between earthed terminal of primary winding and earth shall be 5kV/50Hz/1min	Test voltage 5kV/50Hz/1min No disruptive puncture occurs.	Pass
4	Induced voltage withstand test on primary windings	Induced voltage of the primary windings shall be 275kV/150Hz/40s	Test voltage 275kV/150Hz/40s No puncture occurs. Note: The object is a voltage transformer for GIS. No atmosphere correction needed. Dry ball temperature: 22℃ Relative humidity: 60% Atmospheric pressure: 102.1kPa	Pass
5	Power frequency withstand test on isolation switch fracture	Applied voltage on the opening isolation switch fracture shall be 275kV/50Hz/1min	Test voltage 275 kV/50Hz/1min No disruptive puncture occurs. Note: The object is a voltage transformer for GIS. No atmosphere correction needed.	Pass
6	Partial discharge measurement	Testing frequency: 150 Hz Pre-stress voltage: 275 kV Test voltage : 145 kV PD : ≤ 10 pC Test voltage : 100.5 kV PD : ≤ 5 pC	Testing frequency: 150 Hz Pre-stress voltage : 275 kV Test voltage : 145 kV PD terminal A 7 pC terminal B 6 pC terminal C 7 pC Test voltage : 100.5 kV PD: terminal A 2 pC terminal B 2 pC terminal C 2 pC Background level: 1.8 pC Ambient temperature: 22 ℃ Relative humidity: 60 %	Pass
7	Measurement of Excitation	Providing the test data	Details in appendix No. C.	—
g	Determination of errors	The errors of the second windings should meet the requirement of classes 0.5/3P.	The errors of secondary winding are measured at rated frequency and rated power factor within rated burden. Details in appendix No. D.	Pass

No.	Item	Reference standard	Test result	Conclusion
9	Temperature rise test	<p>The temperature rise of windings can not exceed 75K under the voltage of 1.0Un.</p> <p>The temperature rise of windings can not exceed 75K under the voltage of 1.2Un.</p> <p>The temperature rise of windings can not exceed 10K under the voltage of 1.5Un (beginning from the normality).</p>	<p>The voltage of 1.0Un is applied to primary windings when the secondary windings A2aA2n, B2aB2n, C2aC2n load thermal limiting burden 1000VA. After every part reaching a steady state, the values of temperature rise are shown as follows</p> <p>AN: 16 K A2aA2n: 18 K BN: 17 K B2aB2n: 19 K CN: 17 K C2aC2n: 19 K</p> <p>Ambient temperature 25 °C</p> <p>The voltage of 1.2Un is applied to primary winding when the secondary windings (without residual winding) load rated burden. After every part reaching a steady state, the values of temperature rise are shown as follows</p> <p>AN: 7 K A1aA1n: 8 K A2aA2n: 8 K BN: 8 K B1aB1n: 9 K B2aB2n: 9 K CN: 7 K C1aC1n: 8 K C2aC2n: 7 K</p> <p>Ambient temperature 27 °C</p> <p>The voltage of 1.5Un is applied to primary winding for 30s beginning from the normality when the secondary windings load rated burden. After every part reaching a steady state, the values of temperature rise are shown as follows</p> <p>AN: 0.3 K A1aA1n: 0.3 K A2aA2n: 0.2 K BN: 0.3 K B1aB1n: 0.3 K B2aB2n: 0.4 K CN: 0.4 K C1aC1n: 0.5 K C2aC2n: 0.4 K</p> <p>Ambient temperature 24 °C</p> <p>The details of 1.0Un in appendix No. E</p>	Pass

No.	Item	Reference standard	Test result	Conclusion
10	Measurement of DC resistances of secondary windings	Providing the test data	AN: 44.40 kΩ A1aA1n: 61.64 mΩ A2aA2n: 61.28 mΩ BN: 45.38 kΩ B1aB1n: 63.34 mΩ B2aB2n: 62.68 mΩ CN: 45.25 kΩ C1aC1n: 61.64 mΩ C2aC2n: 60.26 mΩ Ambient temperature 25°C	—
11	Lightning impulse test and chopped lighting impulse test	Applied voltage on primary winding to secondary windings and earth shall be Standard LI: 650kV waveform: 1.2/50μs positive impulses: 15 times negative impulses: 15 times Standard LI-chopped: 748kV waveform: (2~5)μs negative impulses: 2 times	Fifteen consecutive LI in positive and negative polarities and two LI-chopped in negative polarity are applied at primary terminal. Details in appendix No.F. No puncture occurs.	Pass
12	Lightning impulse test on isolation switch fracture	Applied voltage on primary winding Standard LI: 650kV waveform: 1.2/50μs positive impulses: 15 times negative impulses: 15 times	Fifteen consecutive LI in positive and negative polarities are applied at primary terminal. Details in appendix No.G No puncture occurs.	Pass
13	Short-circuit withstand capability test	The rated voltage 63.5V is applied to secondary windings for 1.0s when primary winding is connected with the ground. There shall be no electrical and mechanical damage.	Phase A A1aA1n Secondary voltage 64.2 V Secondary current 477 A Phase B B1aB1n Secondary voltage 64.0 V Secondary current 471 A Phase C C1aC1n Secondary voltage 64.0 V Secondary current 474 A Durative time 1.01 s Waveform in appendix No.H There is no electrical and mechanical damage. Note The primary winding is copper, and the current density in the windings is 26A/mm ² . The secondary windings are copper, and the current density in the windings is 75A/mm ² .	Pass

No.	Item	Reference standard	Test result	Conclusion
14	Power-frequency withstand test on secondary windings(retrial)	Applied voltage on winding-to-winding and winding-to-earth shall be 3kV/50Hz/1min	Test voltage 3kV/50Hz/1min No disruptive puncture occurs.	—
15	Power frequency withstand test on earthed terminal of primary winding(retrial)	Applied voltage between earthed terminal of primary winding and earth shall be 5kV/50Hz/1min	Test voltage 5kV/50Hz/1min No disruptive puncture occurs.	Pass
16	Induced voltage withstand test on primary windings(retrial)	Induced voltage of the primary windings shall be 247.5kV/150Hz/40s	Test voltage 248kV/150Hz/43s No puncture occurs.	Pass
17	Power frequency withstand test on isolation switch fracture(retrial)	Applied voltage on the opening isolation switch fracture shall be 247.5kV/50Hz/1min	Test voltage 248 kV/50Hz/1min No disruptive puncture occurs.	Pass
18	Partial discharge measurement(retrial)	Testing frequency: 150 Hz Pre-stress voltage: 247.5 kV Test voltage : 145 kV PD : ≤ 10 pC Test voltage : 100.5 kV PD : ≤ 5 pC	Testing frequency: 150 Hz Pre-stress voltage : 248 kV Test voltage : 145 kV PD: terminal A 8pC terminal B 6pC terminal C 7pC Test voltage : 101 kV PD: terminal A 2pC terminal B 2pC terminal C 2pC Background level 1.7 pC Ambient temperature: 21 °C Relative humidity: 68%	Pass
19	Measurement of Excitation(retrial)	Providing the test data	A1aA1n : Magnetizing current at rated voltage 4.24A B1aB1n: Magnetizing current at rated voltage 4.22A C1aC1n: Magnetizing current at rated voltage 4.25A	—
20	Determination of errors(retrial)	The errors of the second windings should meet the requirement of class 0.5.	The errors of secondary winding A1aA1n, B1aB1n, C1aC1n are measured at rated frequency and rated power factor within rated burden. Details in appendix No. I.	Pass

No.	Item	Reference standard	Test result	Conclusion
21	Measurement of transmitted overvoltages	Applying impulse-voltage ($10\mu\text{s} \pm 10\%$, $T_2 \geq 100\text{ns}$) between primary winding and earth. The peak-value of transmitted overvoltages of secondary windings should less than 1.6kV.	The peak-value of transmitted overvoltages of secondary windings is 727V~1090V Details in appendix No. J	Pass
22	The gas seal test	The relative ratio of gas giving off in one year should not exceed 0.5% at the rated pressure of 0.50MPa.	The relative ratio of gas giving off in one year doesn't exceed 0.1%	Pass
23	Measurement of the moisture contained in gas	The dew-point is not higher than -38.6°C for a measurement at 20°C . The moisture contained in gas shall be less than $150 \mu\text{L/L}$	The dew-point is -42.5°C at 20°C . The moisture contained in gas is $96 \mu\text{L/L}$	Pass
24	Short time power frequency withstand test on primary winding in the case of no displayed pressure	In the case of no displayed pressure, The test voltage (109kV) shall be applied between the terminal of the primary wind and earth for 5min.	In the case of no displayed pressure Test voltage 109kV/5min No disruptive discharge occurs.	Pass
25	Inspection of core	Clear, no displacement, no distortion. The sizes should accord with the requirements of design.	Photographs in appendix No.L.	Pass

- Note
1. Main test circuits are shown in appendix No.K.
 2. The tests of 1~21 items were performed in the pressure of 0.45MPa. The tests of 22,23 items were performed in the rated pressure of 0.50MPa.
 3. The object is a three-phase voltage transformer with isolation switch for GIS. Photograph of semblance is shown in appendix No.L.

Appendix No.A Main characteristic Parameters of the Sample

Description: Inductive voltage transformer
 Type: JSQXF-145K
 Rated voltage: 132kV
 Rated transformation ratio: $132/\sqrt{3} / 0.11/\sqrt{3} / 0.11/\sqrt{3}$ kV
 Rated insulation level : 145/275/650kV
 Thermal limiting output: 1000VA (A2Aa2n, B2aB2n, C2aC2n load 1000VA)
 Date of Manufacture: October-2013

Sample No.: V1310132060
 Highest voltage for equipment: 145kV
 Rated frequency: 50 Hz

Secondary windings (phase A) Accuracy class		$\frac{A1aA1n}{0.5}$	$\frac{A2aA2n}{3P}$
Rated burden(VA)	A1a A1n	100	100
Power factor=0.8	A2a A2n	100	100
Secondary windings (phase B) Accuracy class		$\frac{B1aB1n}{0.5}$	$\frac{B2aB2n}{3P}$
Rated burden(VA)	B1a B1n	100	100
Power factor=0.8	B2a B2n	100	100
Secondary windings (phase C) Accuracy class		$\frac{C1aC1n}{0.5}$	$\frac{C2aC2n}{3P}$
Rated burden(VA)	C1a C1n	100	100
Power factor=0.8	C2a C2n	100	100

Appendix No.B Parameters of the main equipment

No.	Description/Type	Serial No.	Technical parameter	Accuracy class or uncertainty	Calibration institution	Valid date
1	Voltage transformer for measuring service HJ-220	#03002 (YQ369)	220000/100V	0.02	National center for high voltage measurement	2014.10.29
2	Power-frequency voltage divider FGB-02	#4447 (YQ317)	200V	0.0002	National center for high voltage measurement	2014.01.13
3	Instrument transformer test set HEH-H	#K1020 (YQ320)	150/100V 5/1A	2	National center for high voltage measurement	2014.12.04
4	Current transformer for measuring service HL-61C	#3089 (YQ608)	(5~5000)/5、1A	0.01	National center for high voltage measurement	2015.07.18
5	Partial discharge detector JFD-251	#20051112 (YQ381)	/	10	National center for high voltage measurement	2015.11.04
6	Impulse voltage divider	#550264 (YQ212)	3000kV	3	National center for high voltage measurement	2014.02.06
7	Power-frequency voltage divider TRF250-1000	#060713 (YQ388)	250kV,1020pF	3	National center for high voltage measurement	2014.10.20

Appendix No.C Measurement of Excitation

Percentage of rated secondary voltage(%)		20	50	80	100	120	150
No-load secondary current (A)	phase A A1aA1n	0.88	2.11	3.48	4.26	4.35	3.87
No-load loss (W)		/	/	/	24.2	/	/
No-load secondary current (A)	phase B B1aB1n	0.88	2.15	3.44	4.23	4.26	3.83
No-load loss (W)		/	/	/	23.5	/	/
No-load secondary current (A)	phase C C1aC1n	0.89	2.17	3.46	4.24	4.31	3.89
No-load loss (W)		/	/	/	24.1	/	/
Ambient temperature		22 ℃		Relative humidity		60%	

Appendix No.D Determination of errors

1. Test circuits

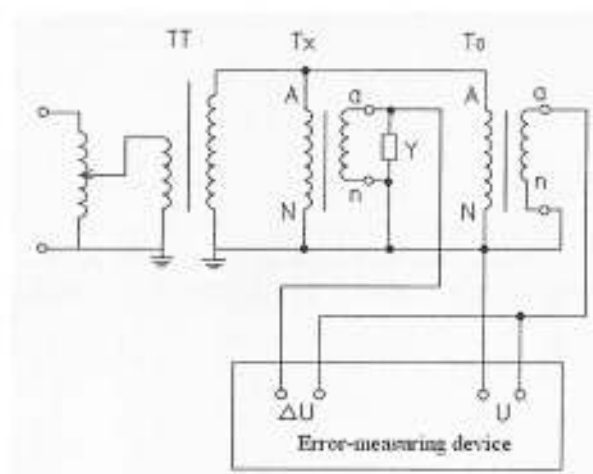

TT: Testing transformer

Tx: Object voltage transformer

T₀: standard voltage transformer

2. Test result

Secondary windings	Accuracy class	Error	Percentage of rated voltage(phase A)			Burden (VA/cos ϕ)	
			80	100	120	A1aA1n	A2aA2n
A1aA1n	0.5	Ratio error(%)	-0.10	-0.10	-0.20	100	100
		Phase displacement(')	-8	-8	-6	0.8	0.8
		Ratio error(%)	+0.40	+0.35	+0.30	25	0
		Phase displacement(')	0	0	0	0.8	
Secondary windings	Accuracy class	Error	Percentage of rated voltage			Burden (VA/cos ϕ)	
A2aA2n	3P	Ratio error(%)	-0.05	-0.10	-0.15	100	100
		Phase displacement(')	-8	-8	-8	0.8	0.8
		Ratio error(%)	+0.40	+0.40	+0.35	0	25
		Phase displacement(')	0	0	0		0.8
Secondary windings	Accuracy class	Error	Percentage of rated voltage			Burden (VA/cos ϕ)	
A2aA2n	3P	Ratio error(%)	-0.35			100	100
		Phase displacement(')	-4			0.8	0.8
		Ratio error(%)	+0.15			0	25
		Phase displacement(')	+4				0.8
Secondary windings	Accuracy class	Error	Percentage of rated voltage(phase B)			Burden (VA/cos ϕ)	
B1aB1n	0.5	Ratio error(%)	-0.10	-0.15	-0.20	100	100
		Phase displacement(')	-8	-8	-6	0.8	0.8
		Ratio error(%)	+0.40	+0.35	+0.30	25	0
		Phase displacement(')	0	0	0	0.8	
Secondary windings	Accuracy class	Error	Percentage of rated voltage			Burden (VA/cos ϕ)	
B2aB2n	3P	Ratio error(%)	-0.10	-0.10	-0.15	100	100
		Phase displacement(')	-8	-8	-8	0.8	0.8
		Ratio error(%)	+0.40	+0.40	+0.35	0	25
		Phase displacement(')	-2	0	0		0.8

Secondary windings	Accuracy class	Error	Percentage of rated voltage			Burden (VA/cos ϕ)	
			150			B1aB1n	B2aB2n
B2aB2n	3P	Ratio error(%)	-0.35			100	100
		Phase displacement(')	-4			0.8	0.8
		Ratio error(%)	+0.10			0	25
		Phase displacement(')	+4				0.8
Secondary windings	Accuracy class	Error	Percentage of rated voltage(phase C)			Burden (VA/cos ϕ)	
			80	100	120	C1aC1n	C2aC2n
C1aC1n	0.5	Ratio error(%)	-0.10	-0.10	-0.20	100	100
		Phase displacement(')	-8	-8	-6	0.8	0.8
		Ratio error(%)	+0.40	+0.35	+0.30	25	0
		Phase displacement(')	0	0	0	0.8	
Secondary windings	Accuracy class	Error	Percentage of rated voltage			Burden (VA/cos ϕ)	
			2	5	100	C1aC1n	C2aC2n
C2aC2n	3P	Ratio error(%)	-0.10	-0.10	-0.15	100	100
		Phase displacement(')	-8	-8	-8	0.8	0.8
		Ratio error(%)	+0.45	+0.40	+0.35	0	25
		Phase displacement(')	-2	0	0		0.8
Secondary windings	Accuracy class	Error	Percentage of rated voltage			Burden (VA/cos ϕ)	
			150			C1aC1n	C2aC2n
C2aC2n	3P	Ratio error(%)	-0.35			100	100
		Phase displacement(')	-4			0.8	0.8
		Ratio error(%)	+0.15			0	25
		Phase displacement(')	+2				0.8
Ambient temperature		22 °C		Relative humidity		60 %	

Appendix No. E Temperature rise test

1.0Un

Temperature-rising curve of AN
The thermal resistance of $R_2=47205 \Omega$

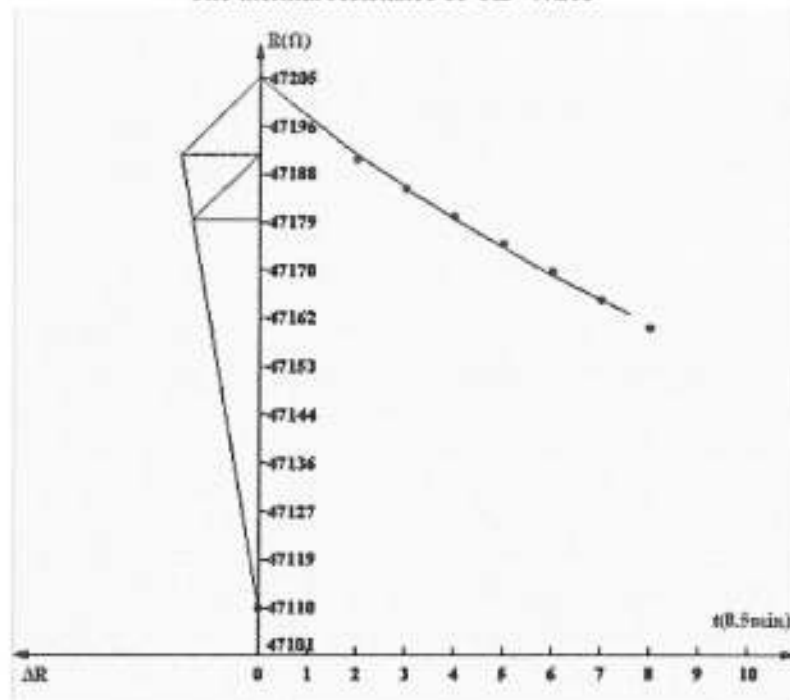

Temperature-rising curve of A2aA2n
The thermal resistance of $R_2=0.065513 \Omega$

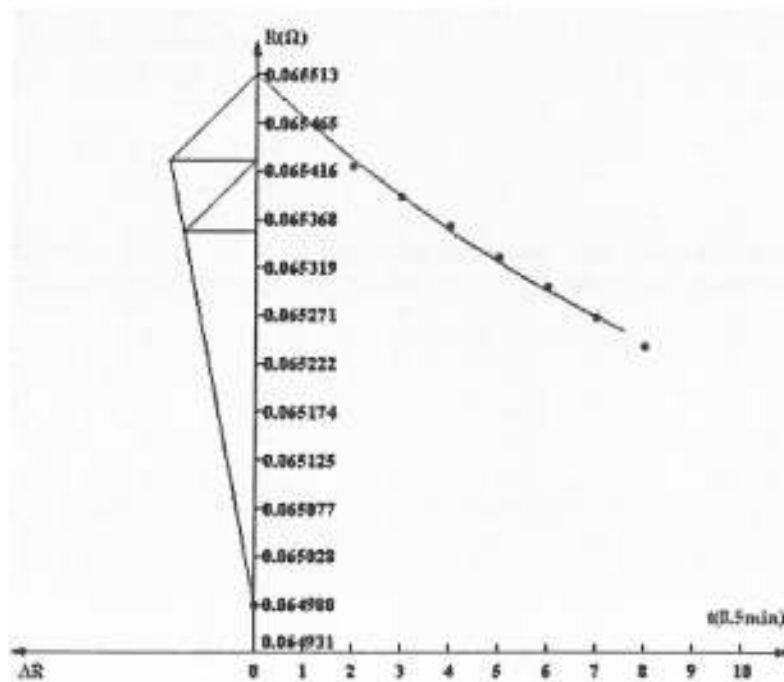

1.0Un

Temperature-rising curve of BN
The thermal resistance of $R_2=48330 \Omega$

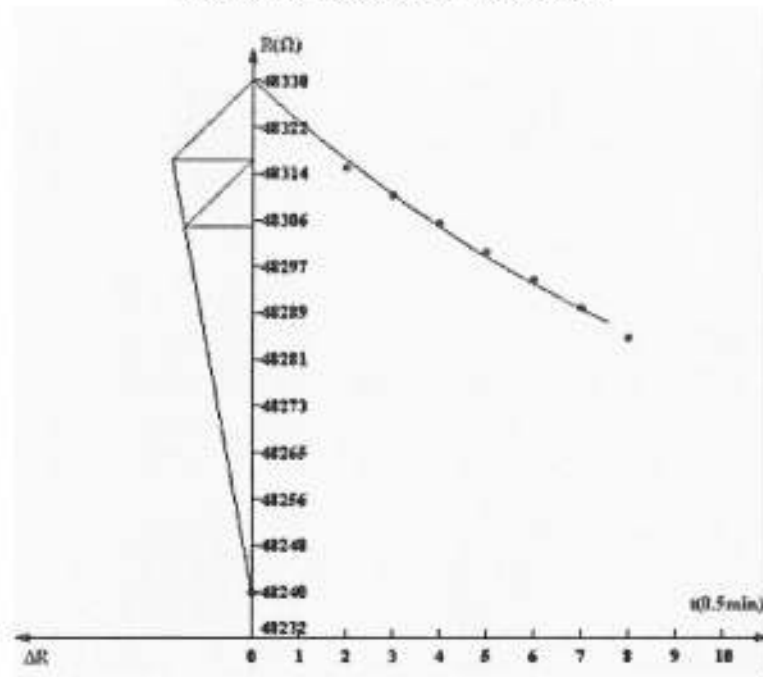

Temperature-rising curve of B2aB2n
The thermal resistance of $R_2=0.067183 \Omega$

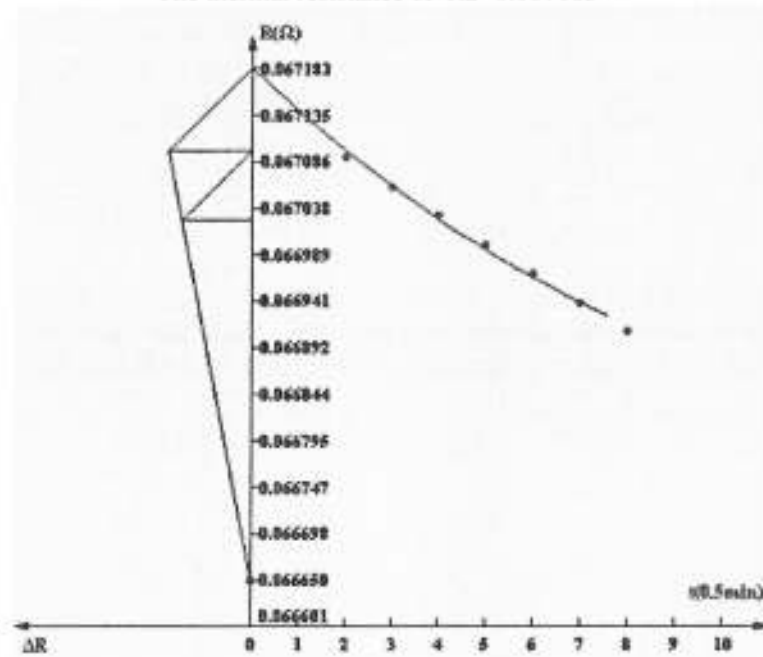

1.0Un

Temperature-rising curve of CN
The thermal resistance of $R_2=48139 \Omega$

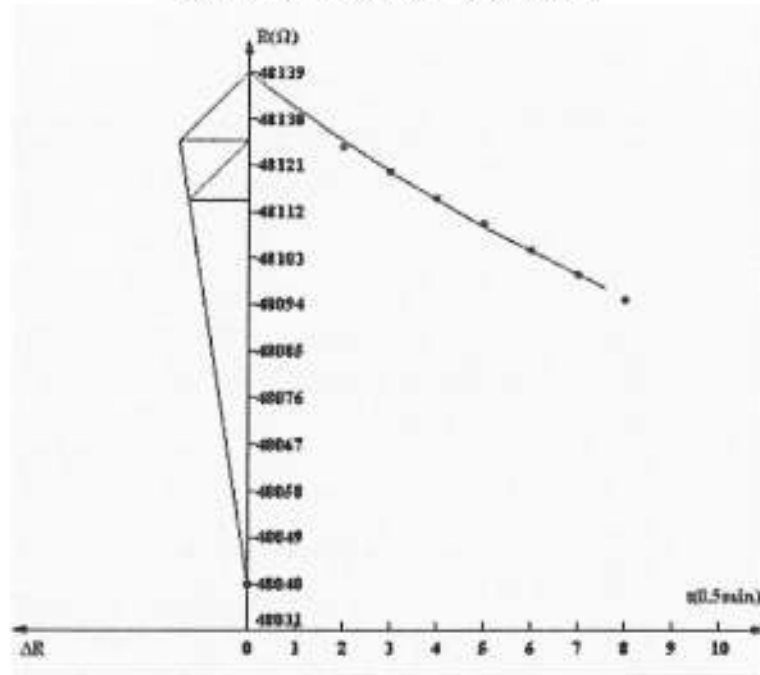

Temperature-rising curve of C2aC2n
The thermal resistance of $R_2=0.064685 \Omega$

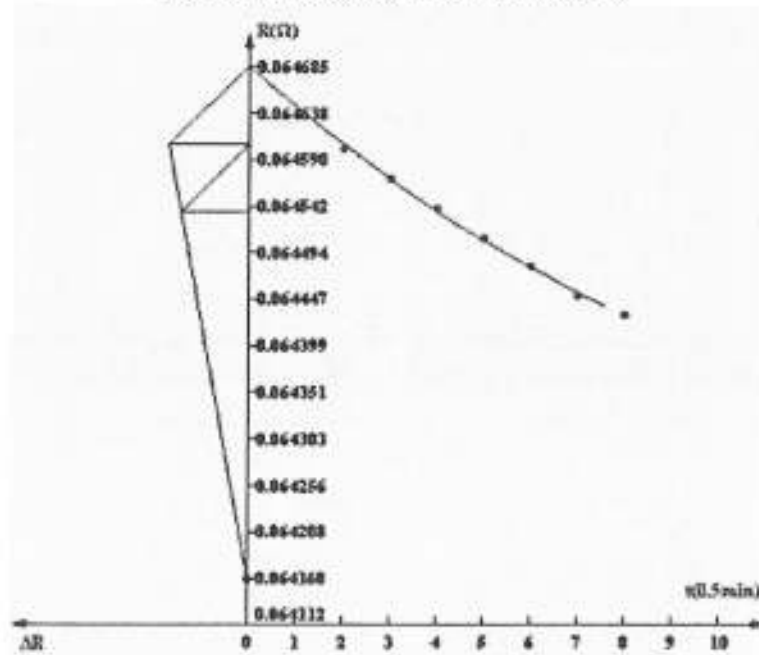

Appendix No.F Lightning impulse test and chopped lightning impulse test

1、 Atmosphere conditions

Ambient temperature 21℃

Relative humidity 58%

2、 Test circuits

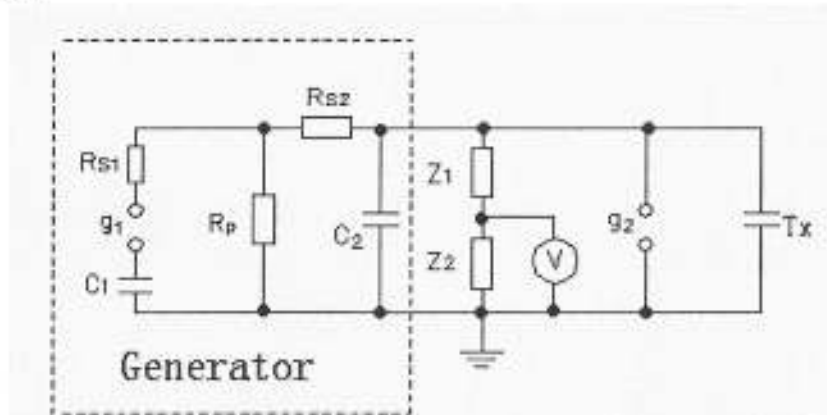

R_{S2} : front resistance R_p : tail resistance g_1 : discharging sphere gap
 g_2 : chopping sphere gap C_1 : front capacitor C_2 : tail capacitor
 Z_1, Z_2 : divider T_x : object V : voltage meter

3、 Test results

Phase A

No.	The standard voltage (peak) (kV)	Waveform of voltage	The test voltage (peak) (kV)	The chopped time(μ s)	Wave-form No.	Result	Remarks
1	325	Pos.LI	347	/	1	OK	/
2	650	Pos.LI	652	/	2	OK	/
3	650	Pos.LI	653	/	3	OK	/
4	650	Pos.LI	652	/	4	OK	/
5	650	Pos.LI	651	/	5	OK	/
6	650	Pos.LI	652	/	6	OK	/
7	650	Pos.LI	653	/	7	OK	/
8	650	Pos.LI	653	/	8	OK	/
9	650	Pos.LI	652	/	9	OK	/
10	650	Pos.LI	653	/	10	OK	/
11	650	Pos.LI	652	/	11	OK	/
12	650	Pos.LI	651	/	12	OK	/

No.	The standard voltage (peak) (kV)	Waveform of voltage	The test voltage (peak) (kV)	The chopped time(μ s)	Wave-form No.	Result	Remarks
13	650	Pos.LI	650	/	13	OK	/
14	650	Pos.LI	652	/	14	OK	/
15	650	Pos.LI	652	/	15	OK	/
16	650	Pos.LI	651	/	16	OK	/
17	325	Neg.LI	346	/	17	OK	/
18	650	Neg.LI	651	/	18	OK	/
19	374	Neg.LI-chopped	389	3.7	19	OK	/
20	748	Neg.LI-chopped	753	3.3	20	OK	/
21	748	Neg.LI-chopped	752	3.1	21	OK	/
22	650	Neg.LI	650	/	22	OK	/
23	650	Neg.LI	653	/	23	OK	/
24	650	Neg.LI	652	/	24	OK	/
25	650	Neg.LI	653	/	25	OK	/
26	650	Neg.LI	652	/	26	OK	/
27	650	Neg.LI	651	/	27	OK	/
28	650	Neg.LI	653	/	28	OK	/
29	650	Neg.LI	652	/	29	OK	/
30	650	Neg.LI	654	/	30	OK	/
31	650	Neg.LI	651	/	31	OK	/
32	650	Neg.LI	653	/	32	OK	/
33	650	Neg.LI	654	/	33	OK	/
34	650	Neg.LI	651	/	34	OK	/
35	650	Neg.LI	653	/	35	OK	/

Phase B

No.	The standard voltage (peak) (kV)	Waveform of voltage	The test voltage (peak) (kV)	The chopped time(μ s)	Wave-form No.	Result	Remarks
1	325	Pos.LI	348	/	I	OK	/

No.	The standard voltage (peak) (kV)	Waveform of voltage	The test voltage (peak) (kV)	The chopped time(μ s)	Wave-form No.	Result	Remarks
2	650	Pos.LI	654	/	2	OK	/
3	650	Pos.LI	652	/	3	OK	/
4	650	Pos.LI	652	/	4	OK	/
5	650	Pos.LI	654	/	5	OK	/
6	650	Pos.LI	653	/	6	OK	/
7	650	Pos.LI	655	/	7	OK	/
8	650	Pos.LI	653	/	8	OK	/
9	650	Pos.LI	655	/	9	OK	/
10	650	Pos.LI	658	/	10	OK	/
11	650	Pos.LI	655	/	11	OK	/
12	650	Pos.LI	655	/	12	OK	/
13	650	Pos.LI	653	/	13	OK	/
14	650	Pos.LI	653	/	14	OK	/
15	650	Pos.LI	654	/	15	OK	/
16	650	Pos.LI	653	/	16	OK	/
17	325	Neg.LI	348	/	17	OK	/
18	650	Neg.LI	654	/	18	OK	/
19	374	Neg.LI-chopped	385	3.6	19	OK	/
20	748	Neg.LI-chopped	753	3.3	20	OK	/
21	748	Neg.LI-chopped	752	3.0	21	OK	/
22	650	Neg.LI	652	/	22	OK	/
23	650	Neg.LI	652	/	23	OK	/
24	650	Neg.LI	653	/	24	OK	/
25	650	Neg.LI	651	/	25	OK	/
26	650	Neg.LI	651	/	26	OK	/
27	650	Neg.LI	651	/	27	OK	/
28	650	Neg.LI	652	/	28	OK	/
29	650	Neg.LI	653	/	29	OK	/
30	650	Neg.LI	653	/	30	OK	/

No.	The standard voltage (peak) (kV)	Waveform of voltage	The test voltage (peak) (kV)	The chopped time(μ s)	Wave-form No.	Result	Remarks
31	650	Neg.LI	652	/	31	OK	/
32	650	Neg.LI	650	/	32	OK	/
33	650	Neg.LI	649	/	33	OK	/
34	650	Neg.LI	651	/	34	OK	/
35	650	Neg.LI	652	/	35	OK	/

Phase C

No.	The standard voltage (peak) (kV)	Waveform of voltage	The test voltage (peak) (kV)	The chopped time(μ s)	Wave-form No.	Result	Remarks
1	325	Pos.LI	347	/	1	OK	/
2	650	Pos.LI	651	/	2	OK	/
3	650	Pos.LI	652	/	3	OK	/
4	650	Pos.LI	650	/	4	OK	/
5	650	Pos.LI	651	/	5	OK	/
6	650	Pos.LI	654	/	6	OK	/
7	650	Pos.LI	652	/	7	OK	/
8	650	Pos.LI	651	/	8	OK	/
9	650	Pos.LI	651	/	9	OK	/
10	650	Pos.LI	650	/	10	OK	/
11	650	Pos.LI	652	/	11	OK	/
12	650	Pos.LI	652	/	12	OK	/
13	650	Pos.LI	653	/	13	OK	/
14	650	Pos.LI	649	/	14	OK	/
15	650	Pos.LI	651	/	15	OK	/
16	650	Pos.LI	650	/	16	OK	/
17	325	Neg.LI	349	/	17	OK	/
18	650	Neg.LI	653	/	18	OK	/
19	374	Neg.LI-chopped	388	3.9	19	OK	/
20	748	Neg.LI-chopped	745	3.5	20	OK	/

No.	The standard voltage (peak) (kV)	Waveform of voltage	The test voltage (peak) (kV)	The chopped time(μ s)	Wave-form No.	Result	Remarks
21	748	Neg.LI-chopped	752	3.3	21	OK	/
22	650	Neg.LI	653	/	22	OK	/
23	650	Neg.LI	654	/	23	OK	/
24	650	Neg.LI	651	/	24	OK	/
25	650	Neg.LI	652	/	25	OK	/
26	650	Neg.LI	653	/	26	OK	/
27	650	Neg.LI	654	/	27	OK	/
28	650	Neg.LI	652	/	28	OK	/
29	650	Neg.LI	651	/	29	OK	/
30	650	Neg.LI	653	/	30	OK	/
31	650	Neg.LI	654	/	31	OK	/
32	650	Neg.LI	650	/	32	OK	/
33	650	Neg.LI	653	/	33	OK	/
34	650	Neg.LI	652	/	34	OK	/
35	650	Neg.LI	653	/	35	OK	/

4、Conclusion Pass

Phase A

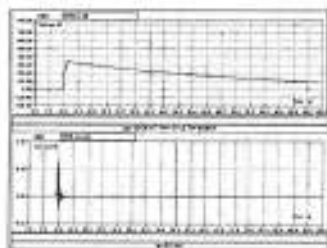
Appendix referential waveform (1.51/48.9 μ s)

No.1

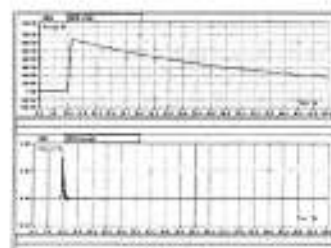

No.2

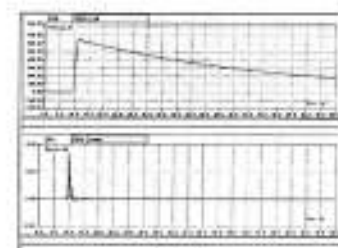

No.3

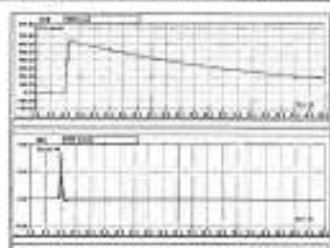

No.4

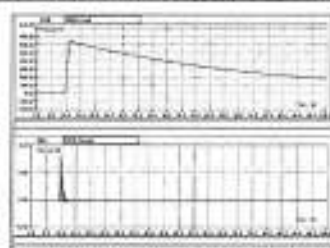

No.5

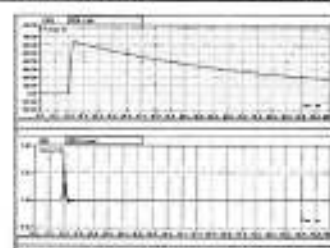

No.6

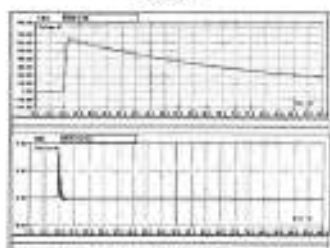

No.7

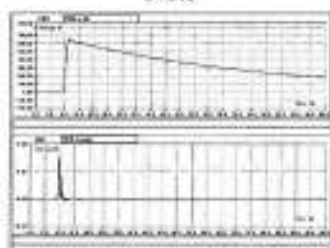

No.8

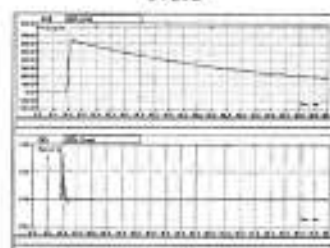

No.9

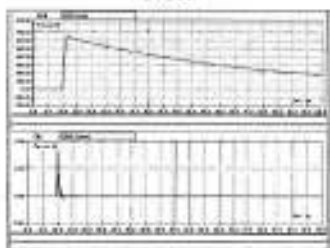

No.10

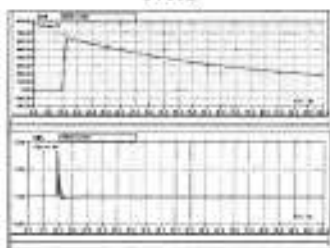

No.11

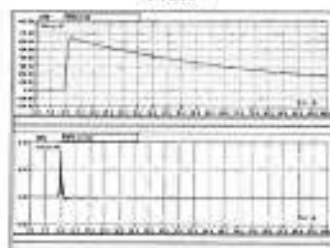

No.12

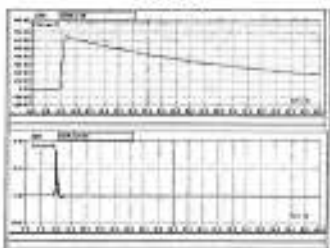

No.13

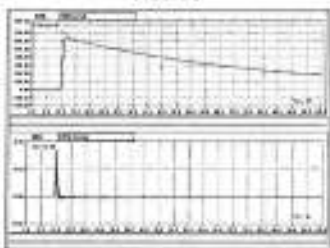

No.14

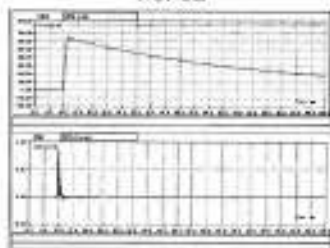

No.15

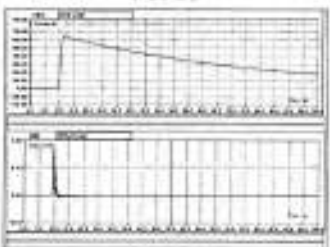

No.16

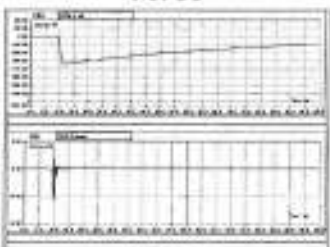

No.17

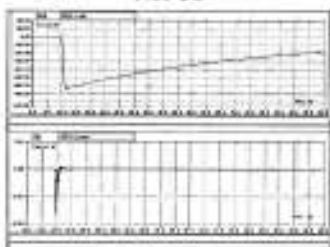

No.18

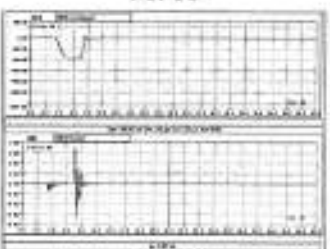

No.19

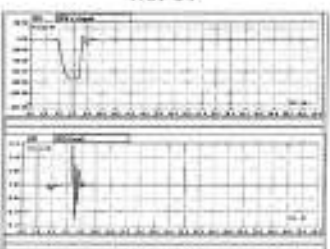

No.20

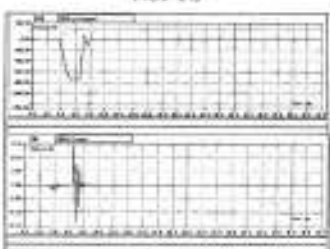

No.21

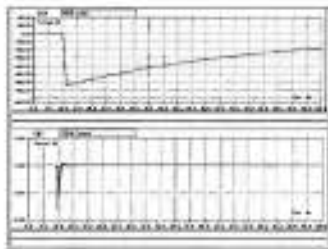

No.22

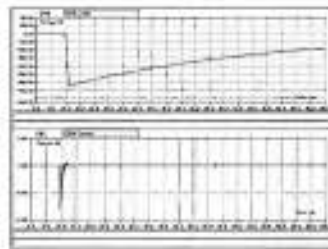

No.23

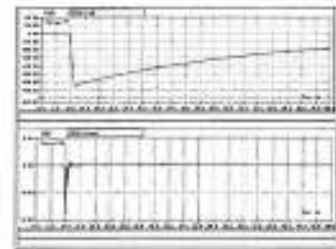

No.24

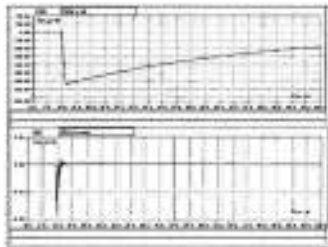

No.25

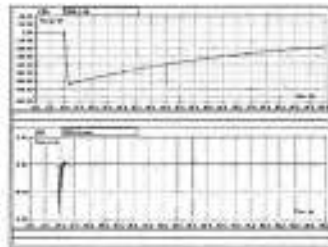

No.26

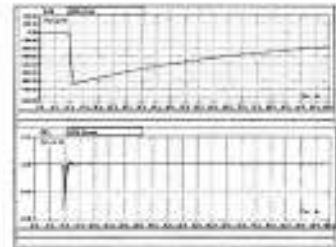

No.27

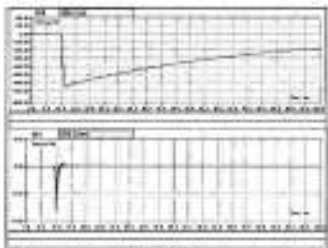

No.28

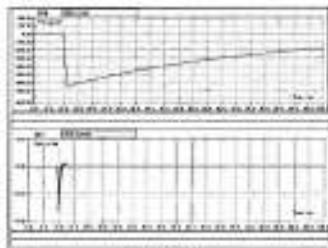

No.29

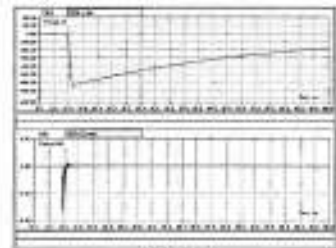

No.30

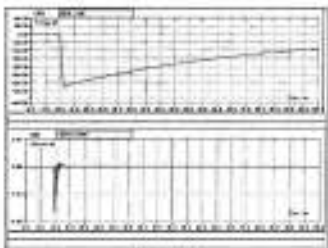

No.31

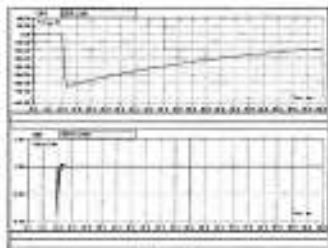

No.32

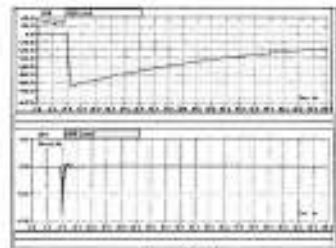

No.33

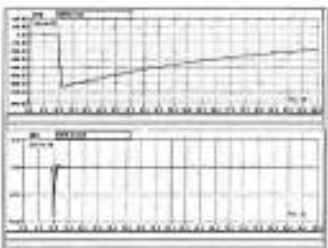

No.34

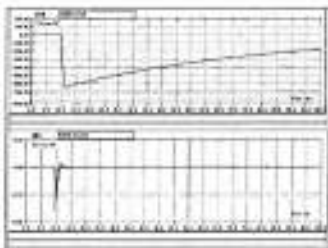

No.35

Phase B
Appendix referential waveform (1.50/48.7 μ s)

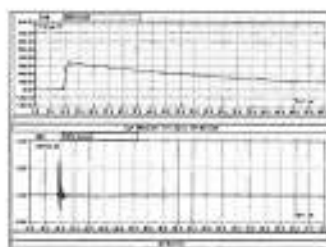
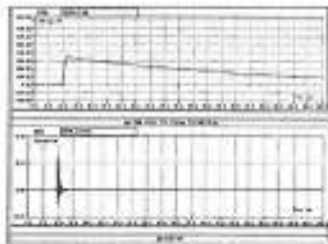

No.1

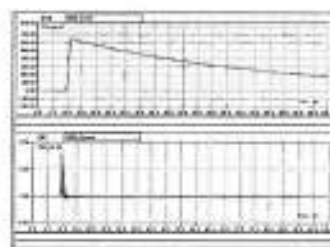

No.2

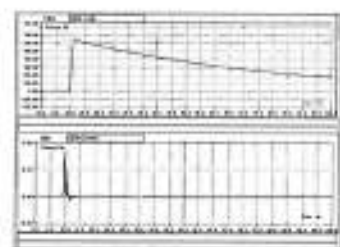

No.3

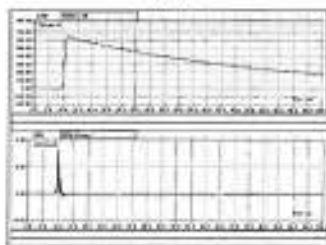

No.4

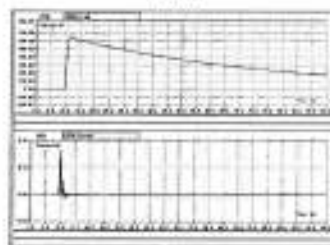

No.5

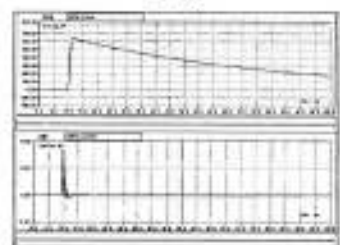

No.6

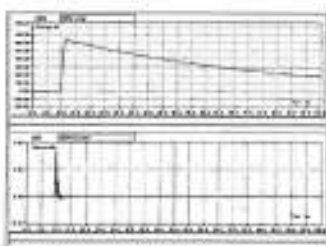

No.7

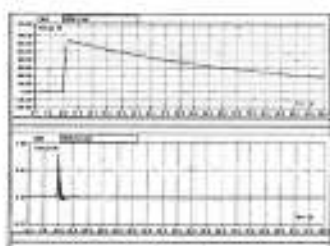

No.8

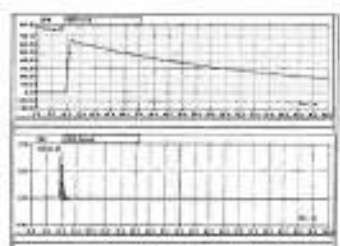

No.9

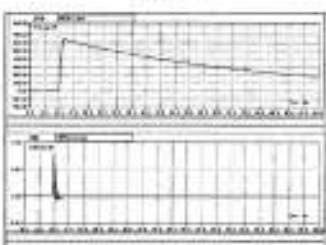

No.10

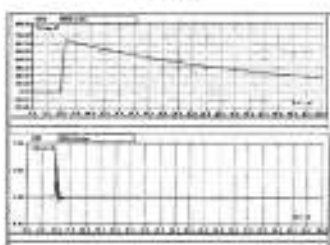

No.11

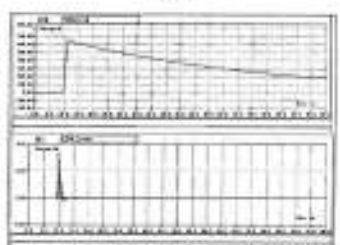

No.12

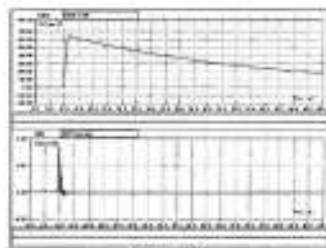

No.13

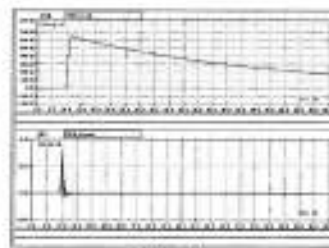

No.14

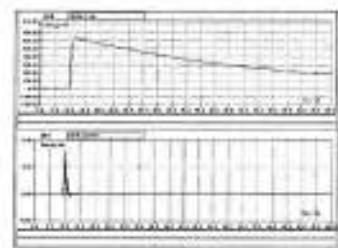

No.15

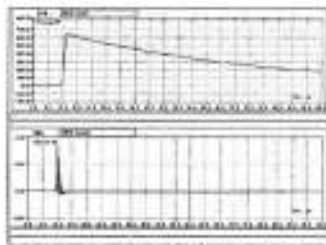

No.16

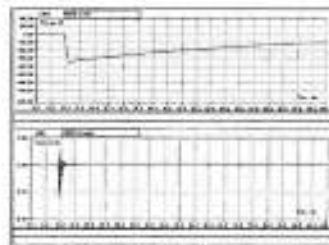

No.17

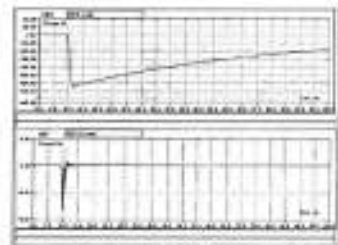

No.18

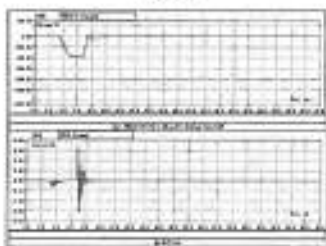

No.19

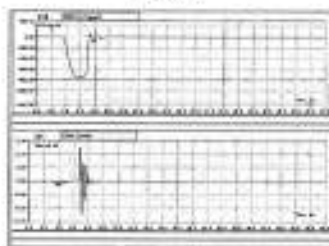

No.20

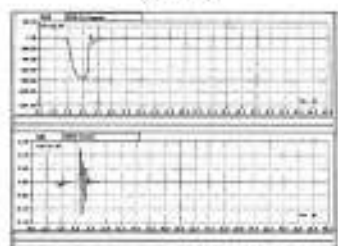

No.21

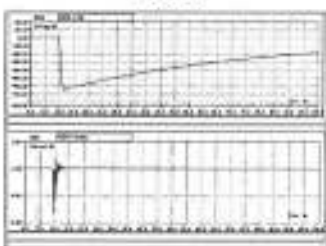

No.22

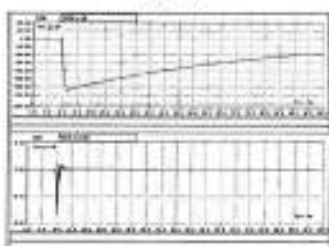

No.23

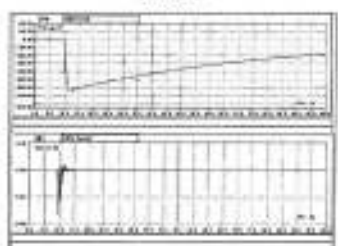

No.24

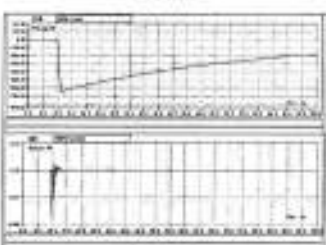

No.25

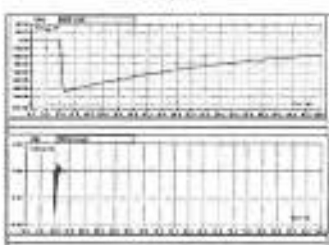

No.26

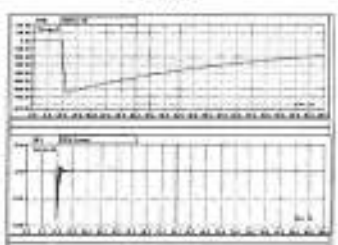

No.27

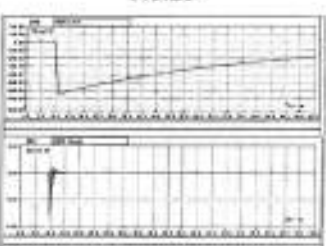

No.28

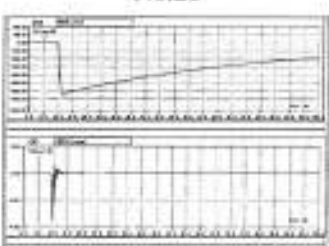

No.29

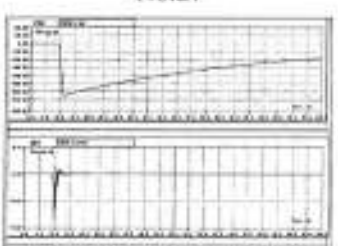

No.30

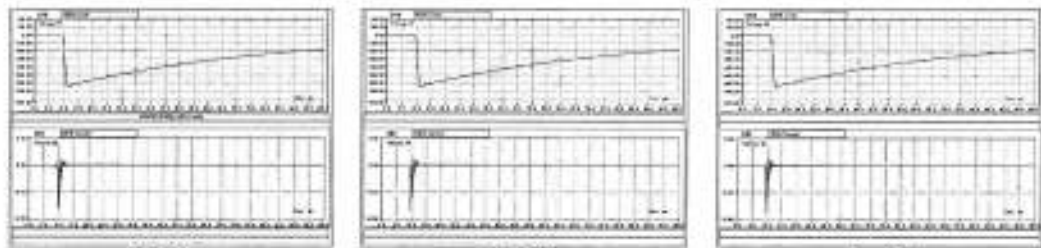

No.31

No.32

No.33

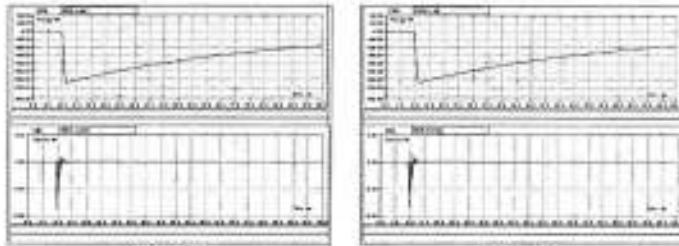

No.34

No.35

Phase C
Appendix referential waveform (1.49/48.7 μs)

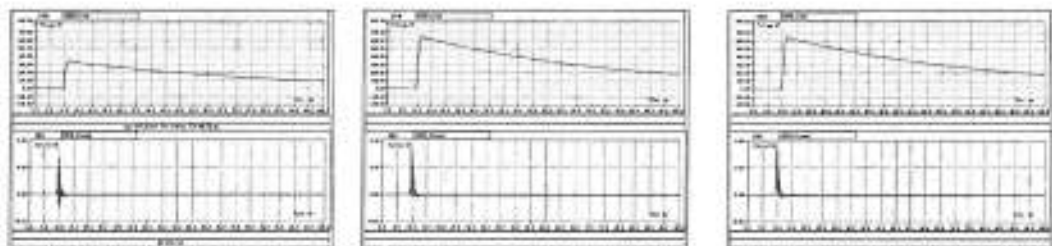
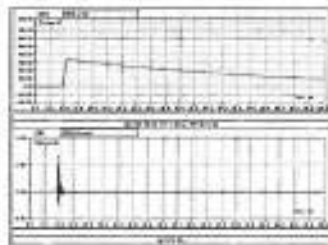

No.1

No.2

No.3

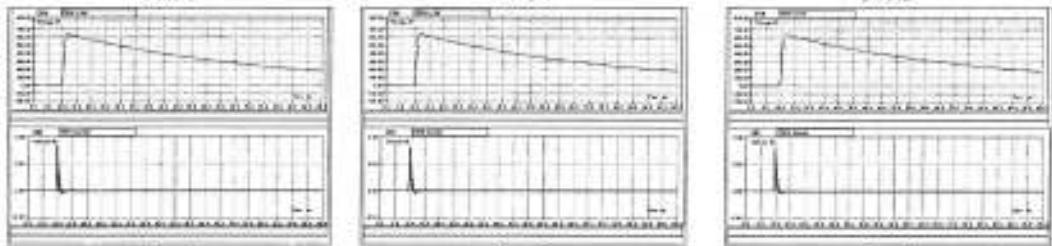

No.4

No.5

No.6

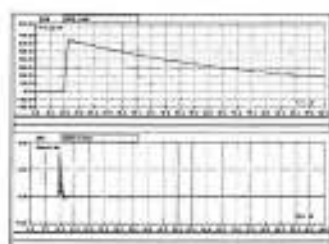

No.7

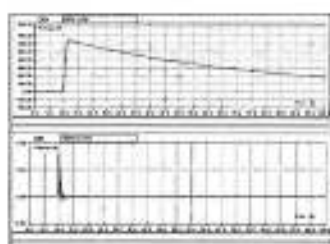

No.8

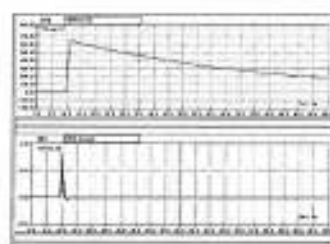

No.9

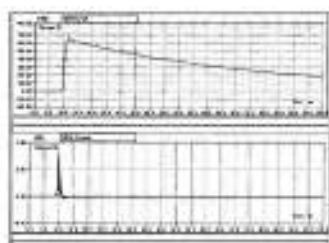

No.10

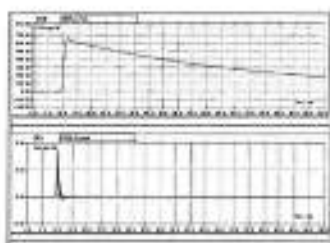

No.11

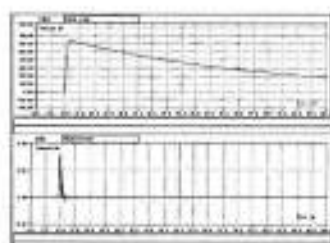

No.12

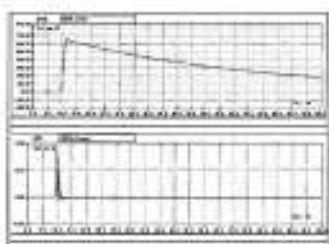

No.13

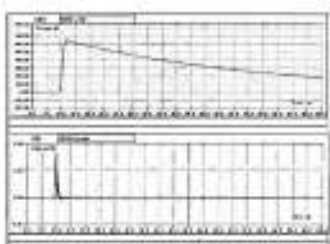

No.14

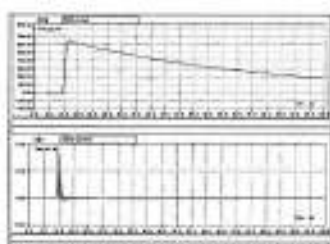

No.15

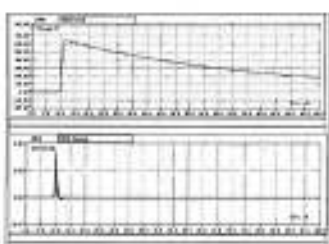

No.16

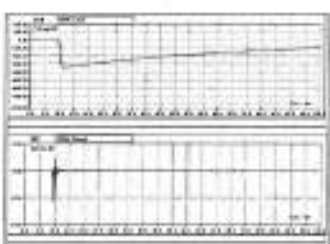

No.17

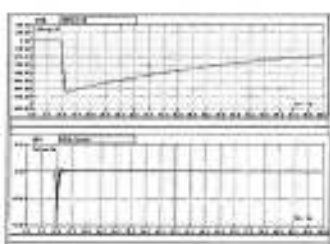

No.18

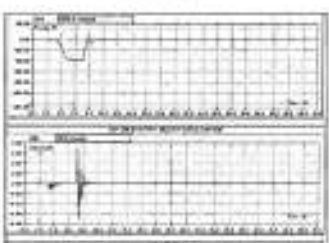

No.19

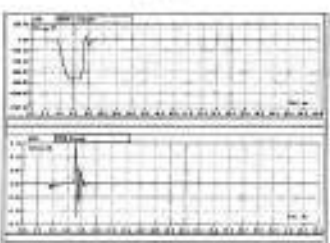

No.20

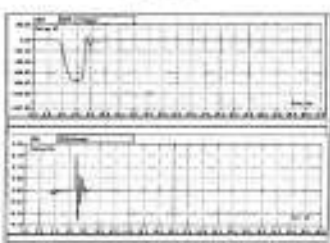

No.21

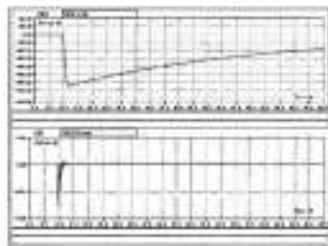

No.22

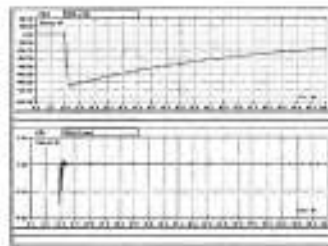

No.23

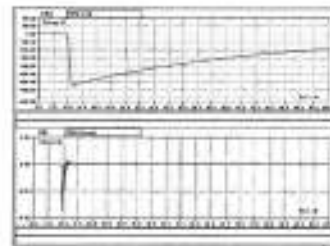

No.24

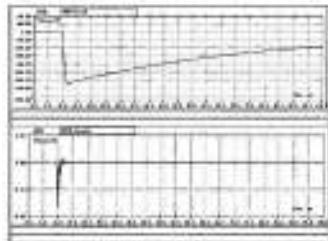

No.25

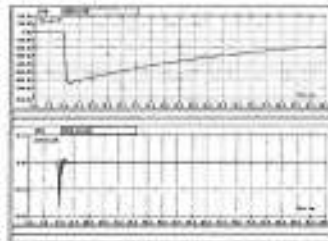

No.26

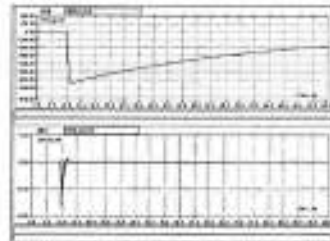

No.27

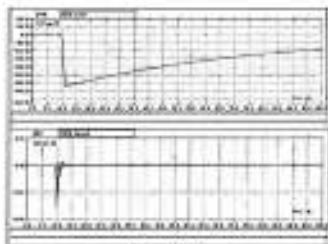

No.28

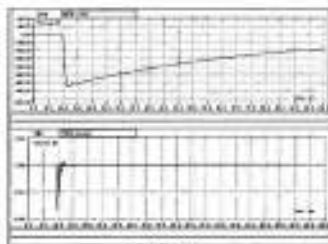

No.29

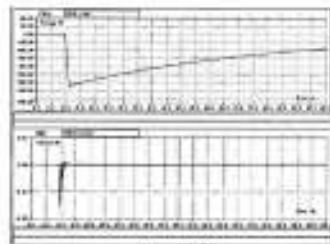

No.30

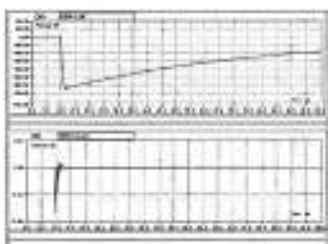

No.31

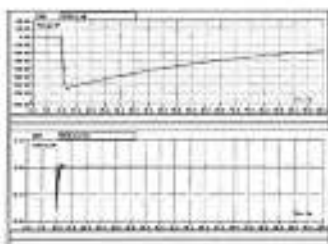

No.32

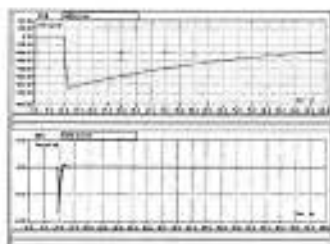

No.33

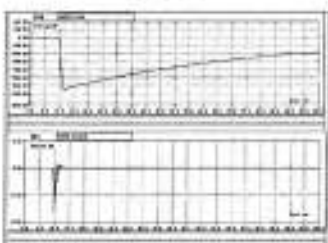

No.34

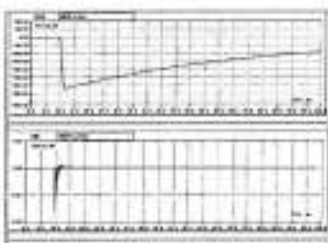

No.35

Appendix No.G Lightning impulse test on isolation switch

1、 Atmosphere conditions

Ambient temperature 21℃

Relative humidity 58%

2、 Test circuits

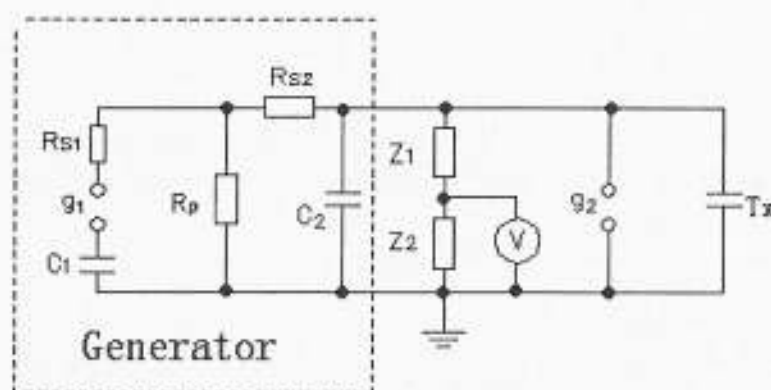

R_{s2} : front resistance R_p : tail resistance g_1 : discharging sphere gap
 g_2 : chopping sphere gap C_1 : front capacitor C_2 : tail capacitor
 Z_1 、 Z_2 : divider T_x : object V : voltage meter

3、 Test results

Phase A

No.	The standard voltage (peak) (kV)	Waveform of voltage	The test voltage (peak) (kV)	The chopped time(μ s)	Wave-form No.	Result	Remarks
1	325	Pos.LI	347	/	1	OK	/
2	650	Pos.LI	651	/	2	OK	/
3	650	Pos.LI	650	/	3	OK	/
4	650	Pos.LI	652	/	4	OK	/
5	650	Pos.LI	652	/	5	OK	/
6	650	Pos.LI	653	/	6	OK	/
7	650	Pos.LI	653	/	7	OK	/
8	650	Pos.LI	649	/	8	OK	/
9	650	Pos.LI	649	/	9	OK	/
10	650	Pos.LI	650	/	10	OK	/
11	650	Pos.LI	651	/	11	OK	/

No.	The standard voltage (peak) (kV)	Waveform of voltage	The test voltage (peak) (kV)	The chopped time(μ s)	Wave-form No.	Result	Remarks
12	650	Pos.LI	651	/	12	OK	/
13	650	Pos.LI	652	/	13	OK	/
14	650	Pos.LI	652	/	14	OK	/
15	650	Pos.LI	650	/	15	OK	/
16	650	Pos.LI	649	/	16	OK	/
17	325	Neg.LI	347	/	17	OK	/
18	650	Neg.LI	653	/	18	OK	/
19	650	Neg.LI	652	/	19	OK	/
20	650	Neg.LI	653	/	20	OK	/
21	650	Neg.LI	652	/	21	OK	/
22	650	Neg.LI	653	/	22	OK	/
23	650	Neg.LI	654	/	23	OK	/
24	650	Neg.LI	651	/	24	OK	/
25	650	Neg.LI	649	/	25	OK	/
26	650	Neg.LI	649	/	26	OK	/
27	650	Neg.LI	650	/	27	OK	/
28	650	Neg.LI	649	/	28	OK	/
29	650	Neg.LI	651	/	29	OK	/
30	650	Neg.LI	651	/	30	OK	/
31	650	Neg.LI	652	/	31	OK	/
32	650	Neg.LI	652	/	32	OK	/

Phase B

No.	The standard voltage (peak) (kV)	Waveform of voltage	The test voltage (peak) (kV)	The chopped time(μ s)	Wave-form No.	Result	Remarks
1	325	Pos.LI	346	/	1	OK	/
2	650	Pos.LI	656	/	2	OK	/
3	650	Pos.LI	652	/	3	OK	/
4	650	Pos.LI	651	/	4	OK	/

No.	The standard voltage (peak) (kV)	Waveform of voltage	The test voltage (peak) (kV)	The chopped time(μ s)	Wave-form No.	Result	Remarks
5	650	Pos.LI	652	/	5	OK	/
6	650	Pos.LI	654	/	6	OK	/
7	650	Pos.LI	653	/	7	OK	/
8	650	Pos.LI	652	/	8	OK	/
9	650	Pos.LI	651	/	9	OK	/
10	650	Pos.LI	653	/	10	OK	/
11	650	Pos.LI	651	/	11	OK	/
12	650	Pos.LI	654	/	12	OK	/
13	650	Pos.LI	650	/	13	OK	/
14	650	Pos.LI	648	/	14	OK	/
15	650	Pos.LI	651	/	15	OK	/
16	650	Pos.LI	649	/	16	OK	/
17	325	Neg.LI	346	/	17	OK	/
18	650	Neg.LI	651	/	18	OK	/
19	650	Neg.LI	652	/	19	OK	/
20	650	Neg.LI	650	/	20	OK	/
21	650	Neg.LI	653	/	21	OK	/
22	650	Neg.LI	652	/	22	OK	/
23	650	Neg.LI	654	/	23	OK	/
24	650	Neg.LI	652	/	24	OK	/
25	650	Neg.LI	648	/	25	OK	/
26	650	Neg.LI	650	/	26	OK	/
27	650	Neg.LI	651	/	27	OK	/
28	650	Neg.LI	653	/	28	OK	/
29	650	Neg.LI	652	/	29	OK	/
30	650	Neg.LI	651	/	30	OK	/
31	650	Neg.LI	654	/	31	OK	/
32	650	Neg.LI	651	/	32	OK	/

Phase C

No.	The standard voltage (peak) (kV)	Waveform of voltage	The test voltage (peak) (kV)	The chopped time(μ s)	Wave-form No.	Result	Remarks
1	325	Pos.LI	347	/	1	OK	/
2	650	Pos.LI	651	/	2	OK	/
3	650	Pos.LI	650	/	3	OK	/
4	650	Pos.LI	652	/	4	OK	/
5	650	Pos.LI	653	/	5	OK	/
6	650	Pos.LI	651	/	6	OK	/
7	650	Pos.LI	652	/	7	OK	/
8	650	Pos.LI	653	/	8	OK	/
9	650	Pos.LI	652	/	9	OK	/
10	650	Pos.LI	650	/	10	OK	/
11	650	Pos.LI	649	/	11	OK	/
12	650	Pos.LI	652	/	12	OK	/
13	650	Pos.LI	651	/	13	OK	/
14	650	Pos.LI	653	/	14	OK	/
15	650	Pos.LI	652	/	15	OK	/
16	650	Pos.LI	650	/	16	OK	/
17	325	Neg.LI	347	/	17	OK	/
18	650	Neg.LI	653	/	18	OK	/
19	650	Neg.LI	652	/	19	OK	/
20	650	Neg.LI	650	/	20	OK	/
21	650	Neg.LI	651	/	21	OK	/
22	650	Neg.LI	649	/	22	OK	/
23	650	Neg.LI	652	/	23	OK	/
24	650	Neg.LI	653	/	24	OK	/
25	650	Neg.LI	651	/	25	OK	/
26	650	Neg.LI	653	/	26	OK	/
27	650	Neg.LI	652	/	27	OK	/
28	650	Neg.LI	650	/	28	OK	/

No.	The standard voltage (peak) (kV)	Waveform of voltage	The test voltage (peak) (kV)	The chopped time(μ s)	Wave-form No.	Result	Remarks
29	650	Neg.LI	649	/	29	OK	/
30	650	Neg.LI	652	/	30	OK	/
31	650	Neg.LI	653	/	31	OK	/
32	650	Neg.LI	651	/	32	OK	/

4、Conclusion Pass

Phase A

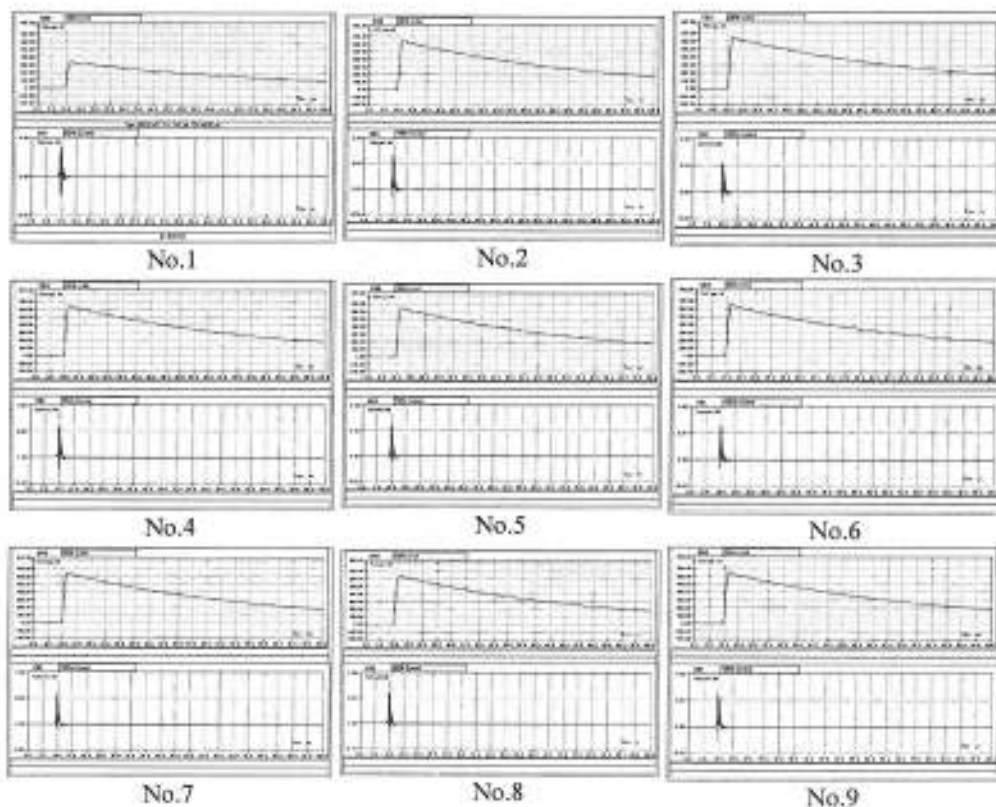
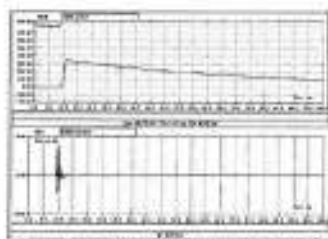
Appendix referential waveform (1.47/48.7 μ s)

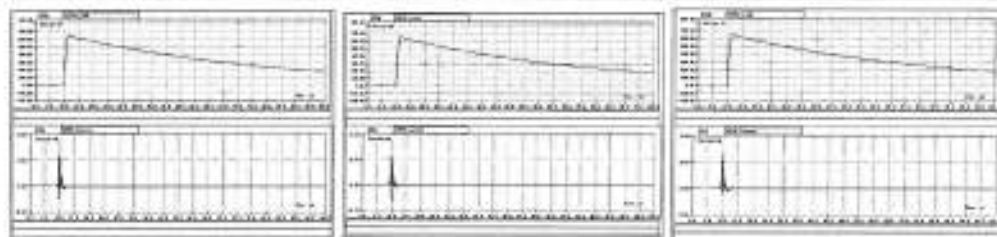

No.10

No.11

No.12

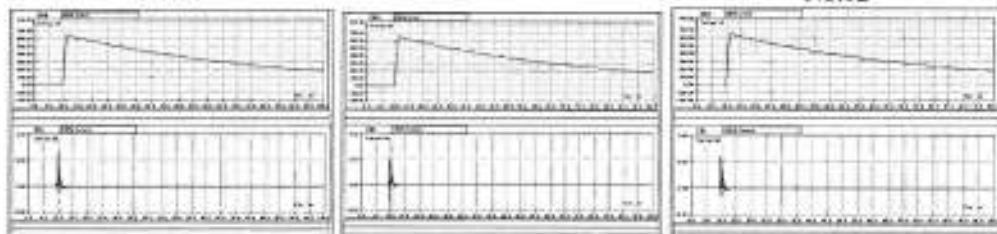

No.13

No.14

No.15

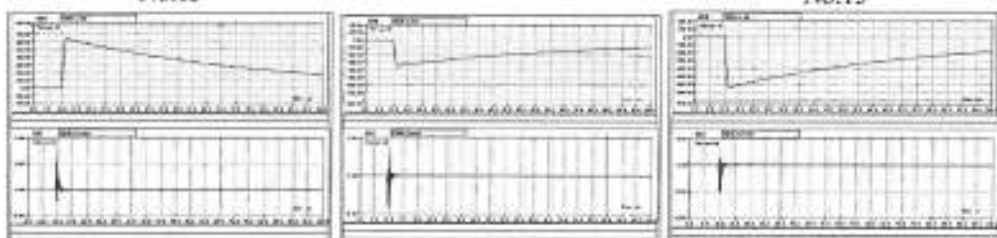

No.16

No.17

No.18

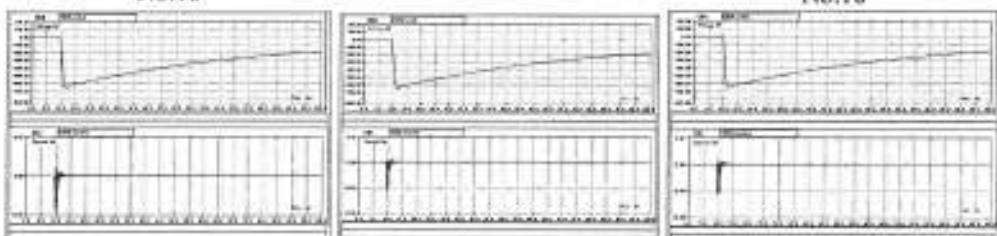

No.19

No.20

No.21

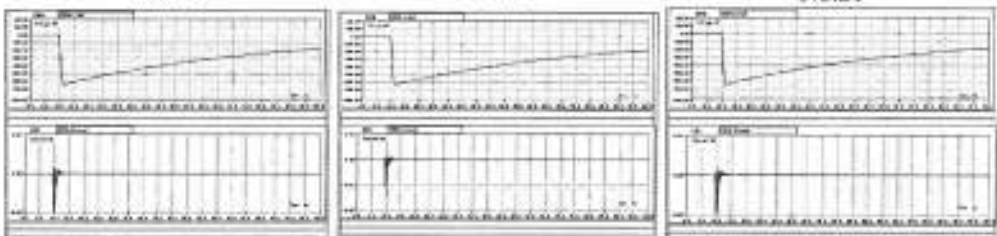

No.22

No.23

No.24

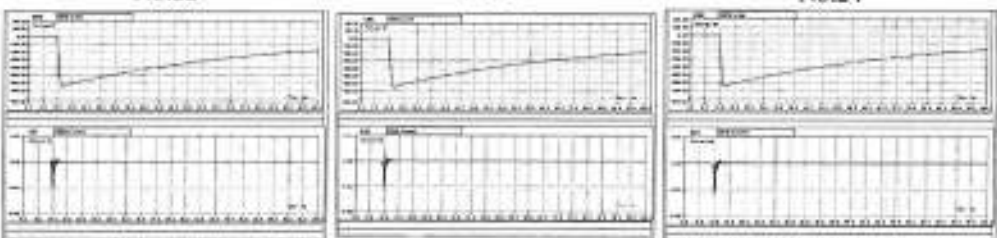

No.25

No.26

No.27

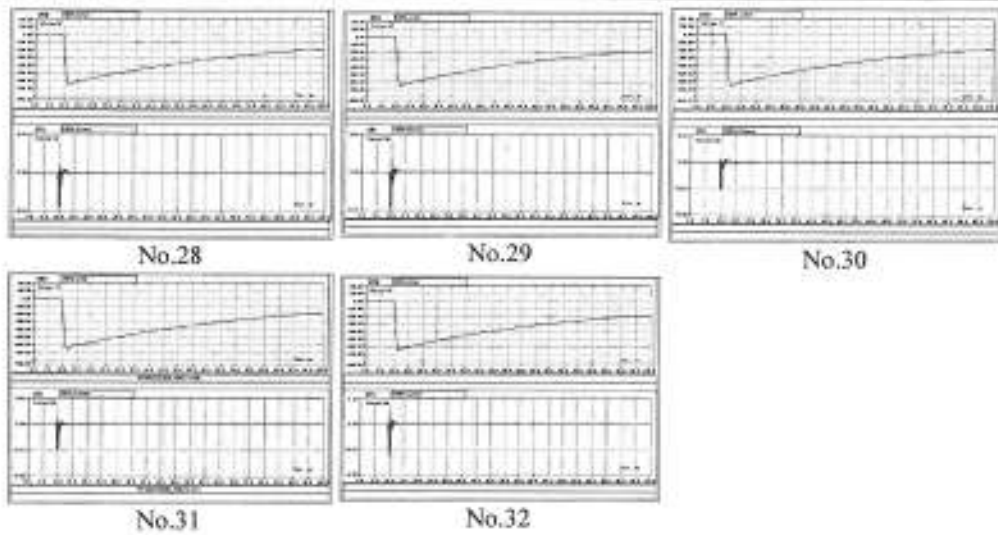

Phase B
Appendix referential waveform (1.46/48.5 μs)

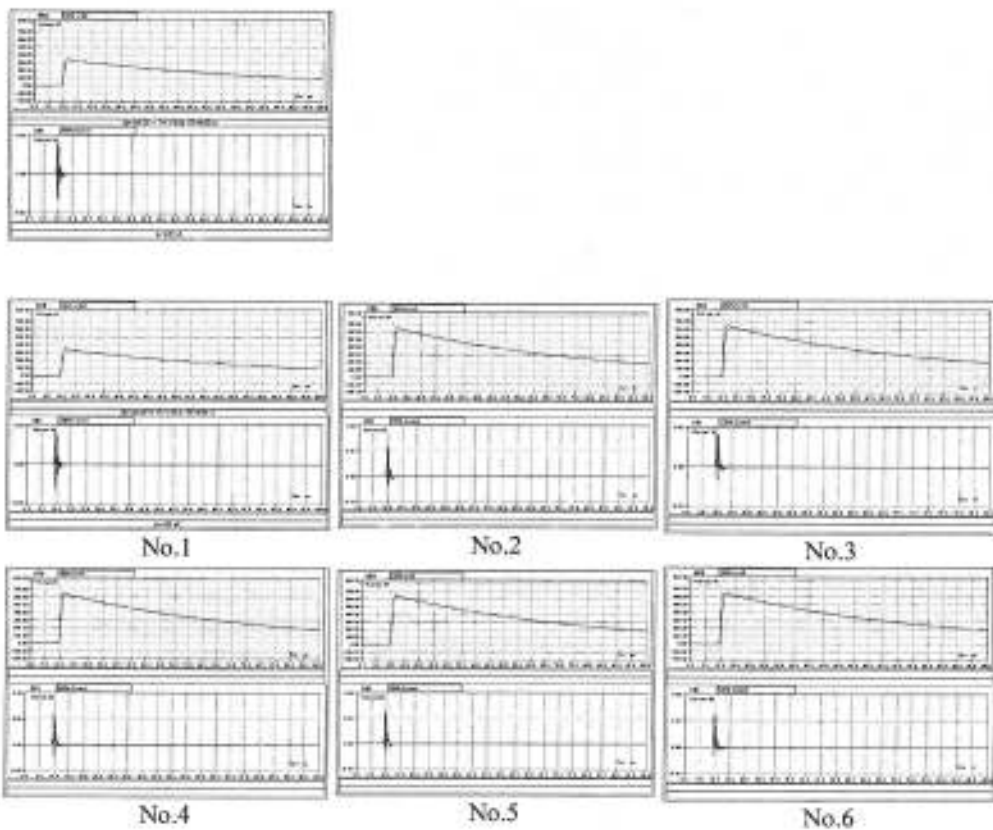

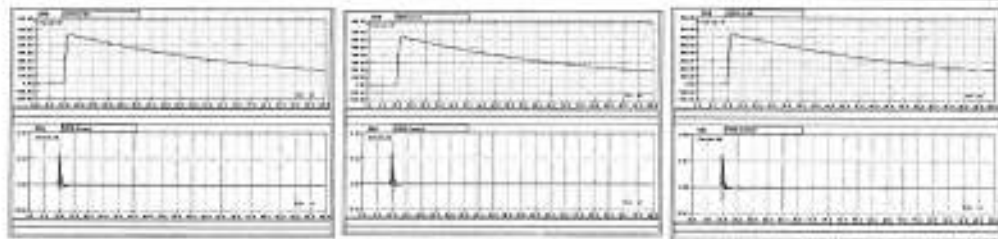

No.7

No.8

No.9

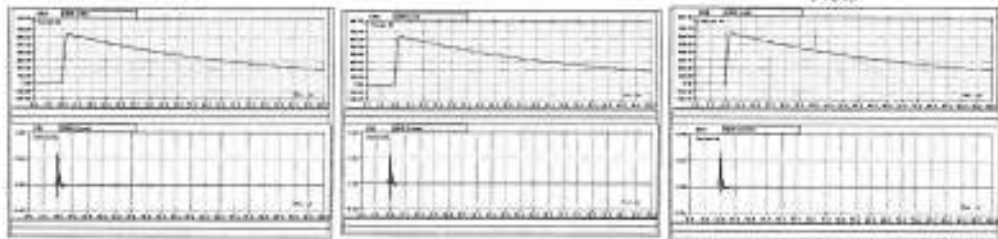

No.10

No.11

No.12

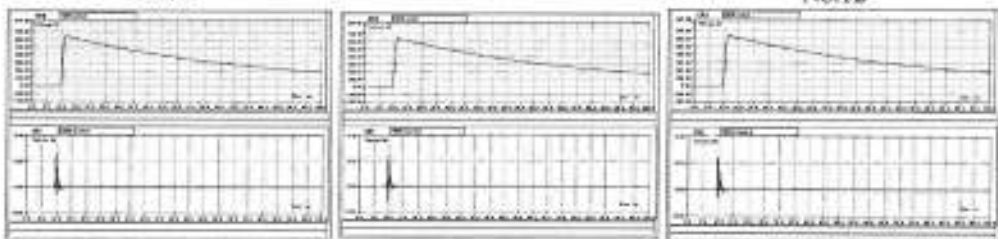

No.13

No.14

No.15

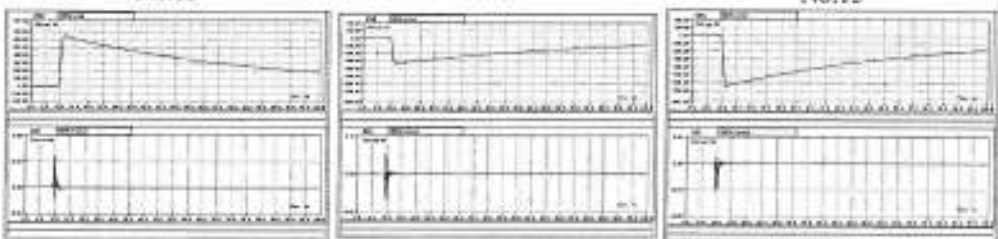

No.16

No.17

No.18

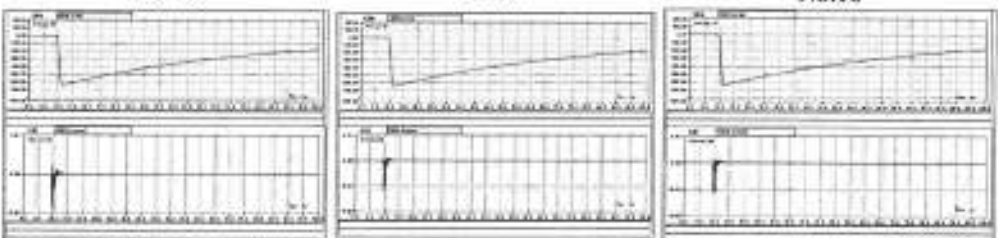

No.19

No.20

No.21

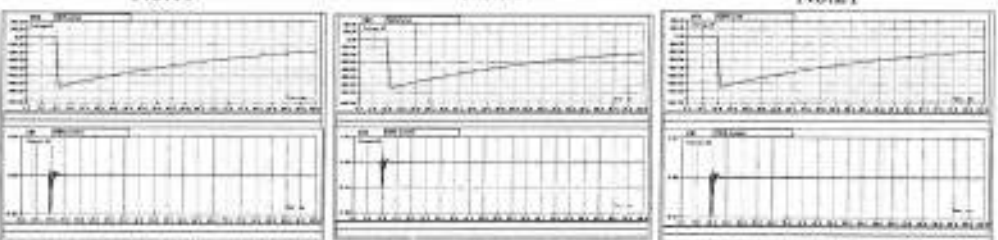

No.22

No.23

No.24

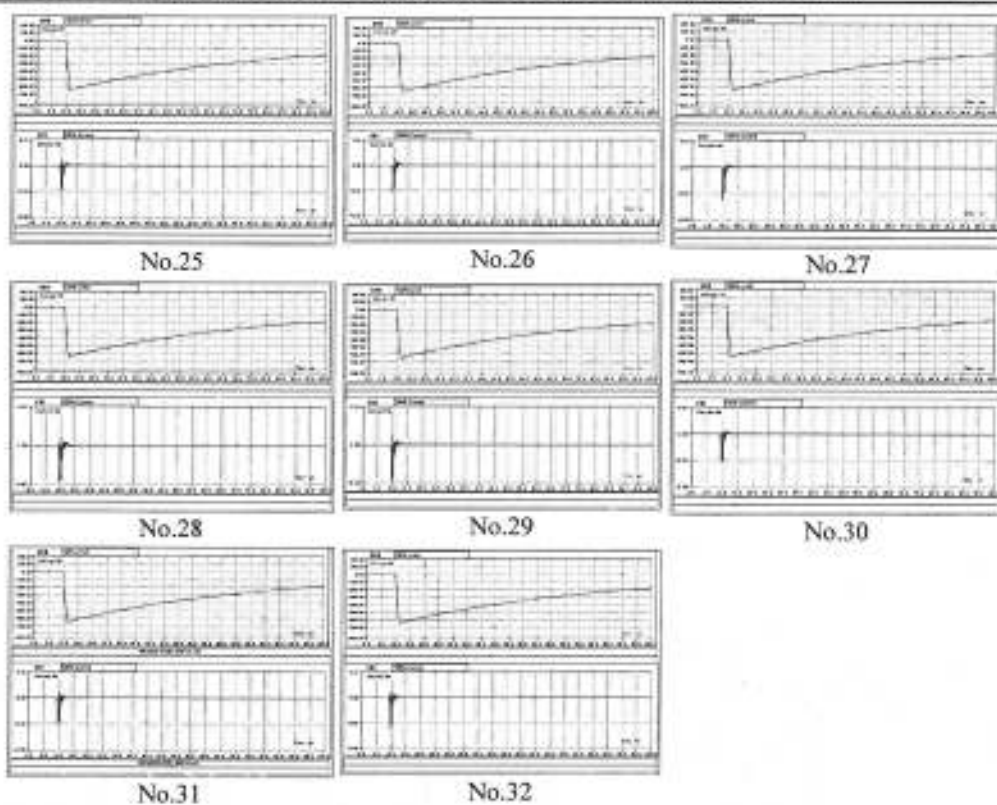

Phase C

Appendix

referential waveform

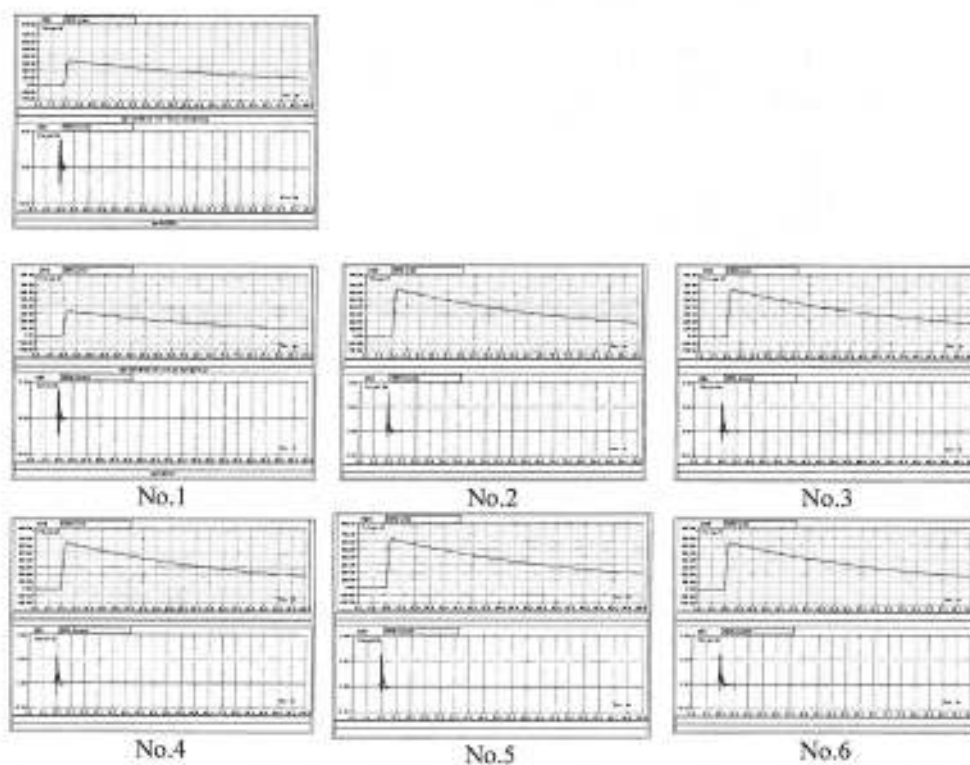
(1.47/48.7 μ s)

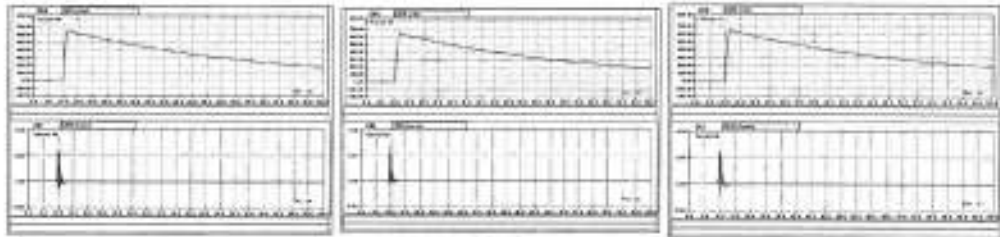

No.7

No.8

No.9

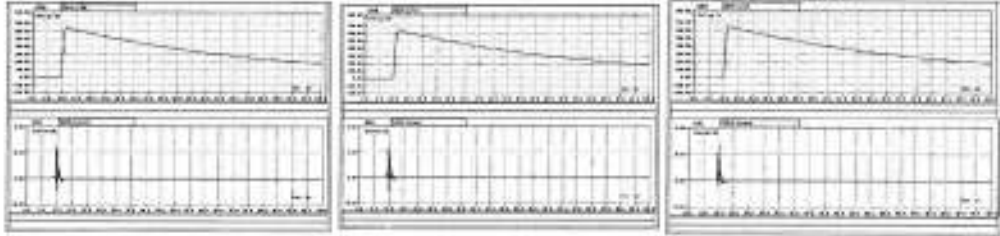

No.10

No.11

No.12

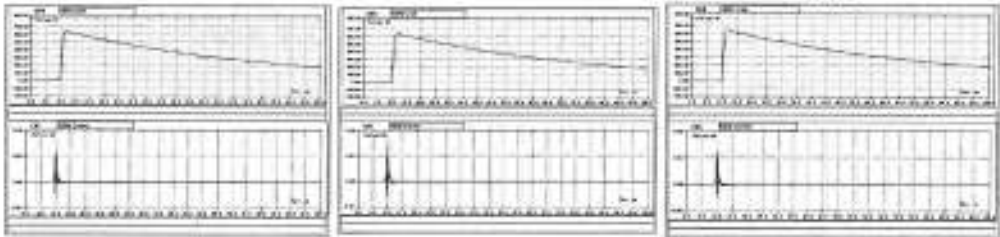

No.13

No.14

No.15

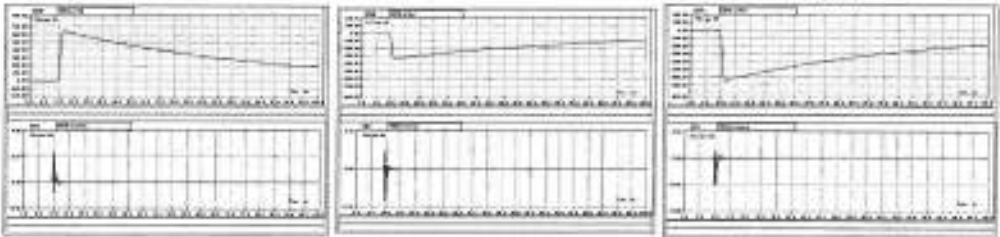

No.16

No.17

No.18

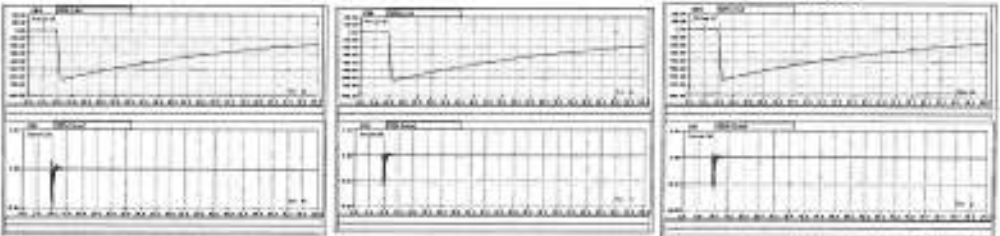

No.19

No.20

No.21

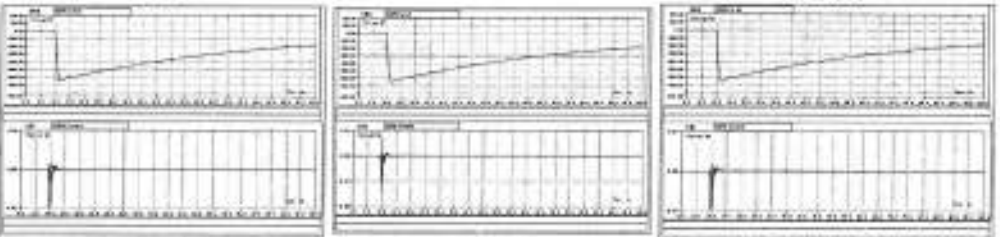

No.22

No.23

No.24

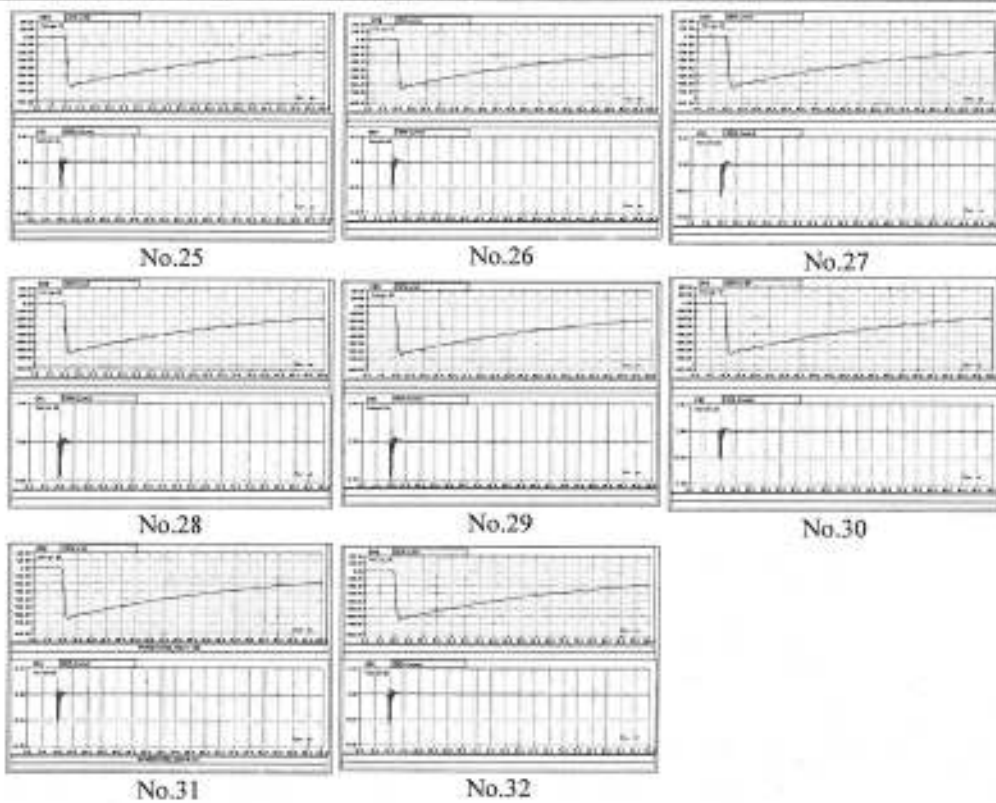

Appendix No.H Endurance of short circuit

1. Test circuits

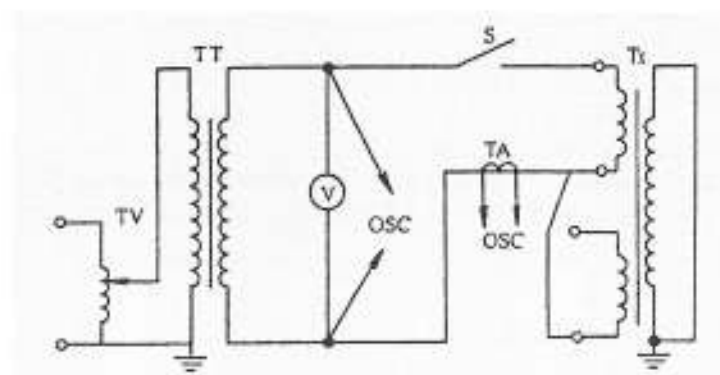

TV: AC voltage regulator

TA: Measuring current transformer

Tx: Object voltage transformer

TT: Transformer

OSC: Recording oscillograph

S: Switch

V: Voltage meter

2. Test waveform

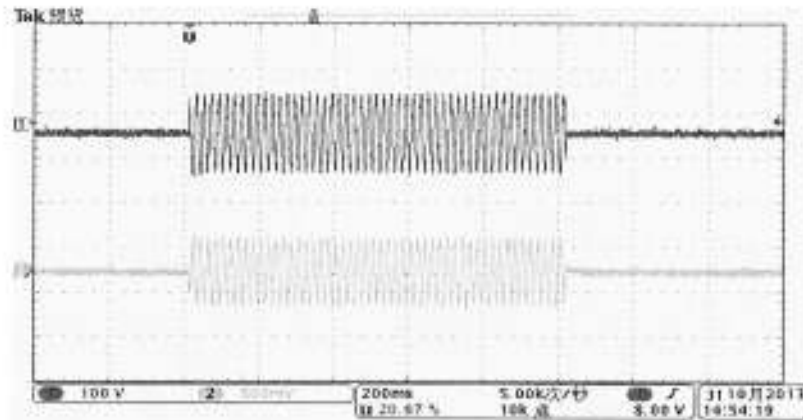

U

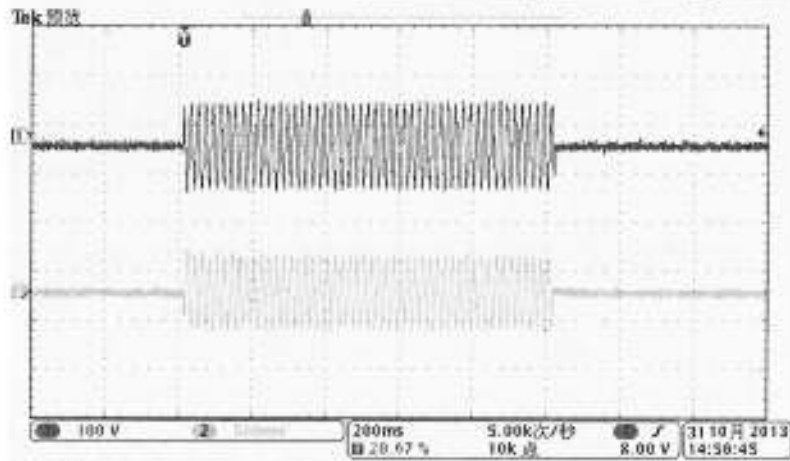
I($R_0=0.12 \Omega$)
phase A

U

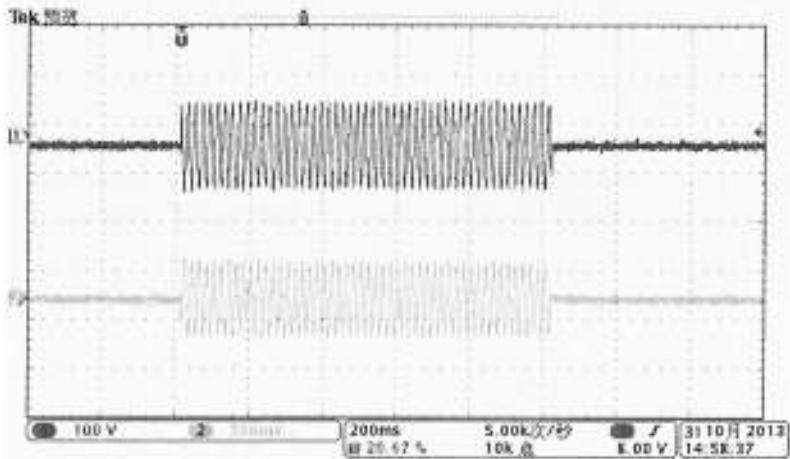
I($R_0=0.12 \Omega$)
phase B

U

I($R_0=0.12 \Omega$)
phase C

Appendix No.I Determination of errors(retrial)

Secondary windings	Accuracy class	Error	Percentage of rated voltage(Phase A)			Burden (VA/cos ϕ)	
			80	100	120	A1aA1n	A2aA2n
A1aA1n	0.5	Ratio error(%)	-0.10	-0.10	-0.20	100	100
		Phase displacement(')	-8	-6	-6	0.8	0.8
		Ratio error(%)	+0.40	+0.35	+0.30	25	0
		Phase displacement(')	0	0	0	0.8	
Secondary windings	Accuracy class	Error	Percentage of rated voltage(Phase B)			Burden (VA/cos ϕ)	
			80	100	120	B1aB1n	B2aB2n
B1aB1n	0.5	Ratio error(%)	-0.10	-0.15	-0.20	100	100
		Phase displacement(')	-8	-6	-6	0.8	0.8
		Ratio error(%)	+0.40	+0.35	+0.30	25	0
		Phase displacement(')	0	0	0	0.8	
Secondary windings	Accuracy class	Error	Percentage of rated voltage(Phase C)			Burden (VA/cos ϕ)	
			80	100	120	C1aC1n	C2aC2n
C1aC1n	0.5	Ratio error(%)	-0.10	-0.10	-0.20	100	100
		Phase displacement(')	-8	-8	-6	0.8	0.8
		Ratio error(%)	+0.40	+0.35	+0.30	25	0
		Phase displacement(')	0	0	0	0.8	
Ambient temperature		21 °C		Relative humidity		68 %	

Appendix No. J Transmitted overvoltage measurement

1、 Atmosphere conditions

Room temperature 16 ℃

Relative humidity 58 %

2、 Test circuits

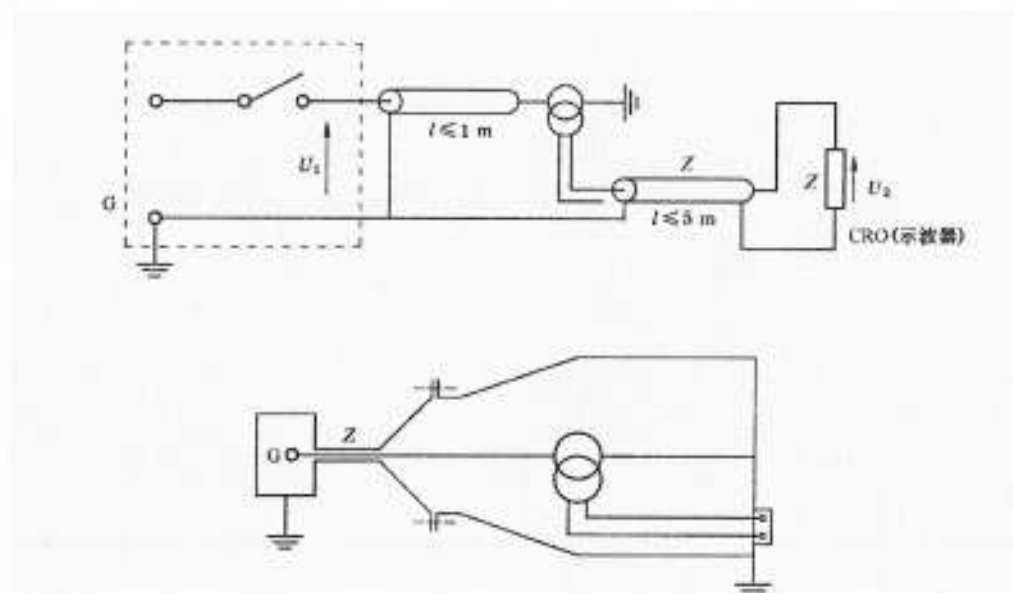

G: Generator

OSC: OSC

3、 Test results

Secondary windings	Type of impulse-voltage	Applying impulse-voltage on primary winding(U_1) (kV)	The peak-voltage of secondary windings (U_2) (V)	The peak-voltage of transmission over-voltage (U_0) (V)	Waveform No.
	T_1 ns T_2 ns				
Phase A	A1aA1n	208	1.2	1090	1
	A2aA2n	211	1.0	896	2
Phase B	B1aB1n	210	1.2	1080	3
	B2aB2n	208	0.9	818	4
Phase C	C1aC1n	216	0.9	788	5
	C2aC2n	208	0.8	727	6

$$\text{Note } U_p = \frac{U_2}{U_1} \times U_p \quad U_p = 1.6 \frac{\sqrt{2}U_m}{\sqrt{3}}$$

4. Conclusion Pass

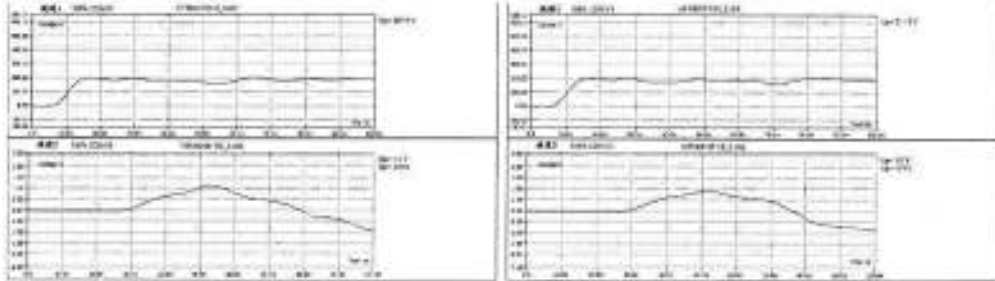

No.1

No.2

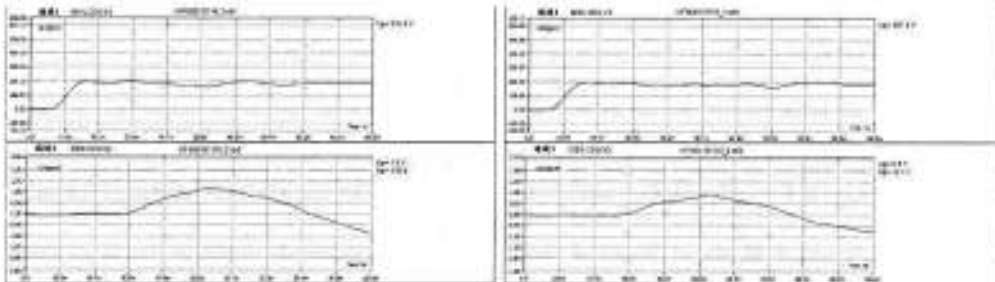

No.3

No.4

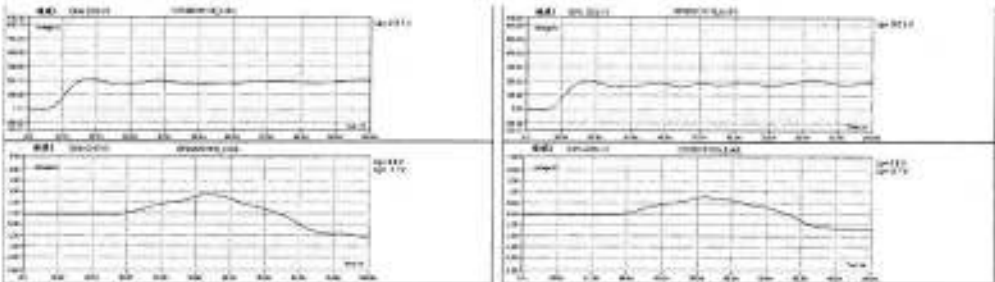

No.5

No.6

Appendix No.K Main test circuits

Figure1—Power-frequency withstand test on primary windings

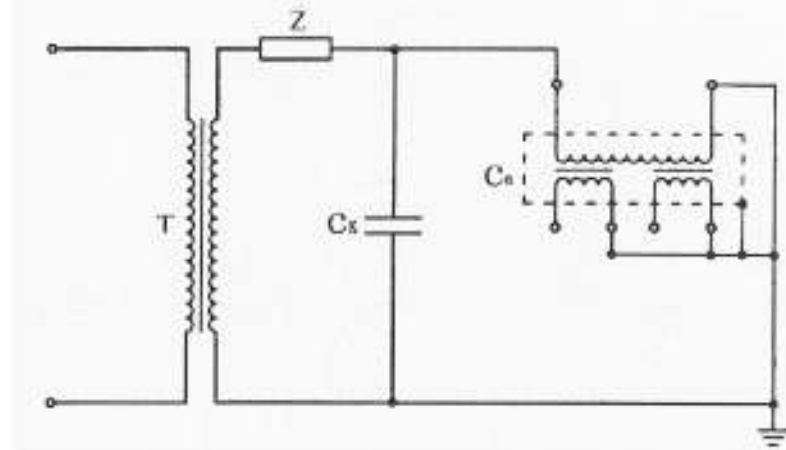

- C_o —Object
 C_x —Coupling capacitor
 Z —filter (if C_x refers to capacitance of testing transformer, Filter is unnecessary)

Figure2—Partial discharge tests

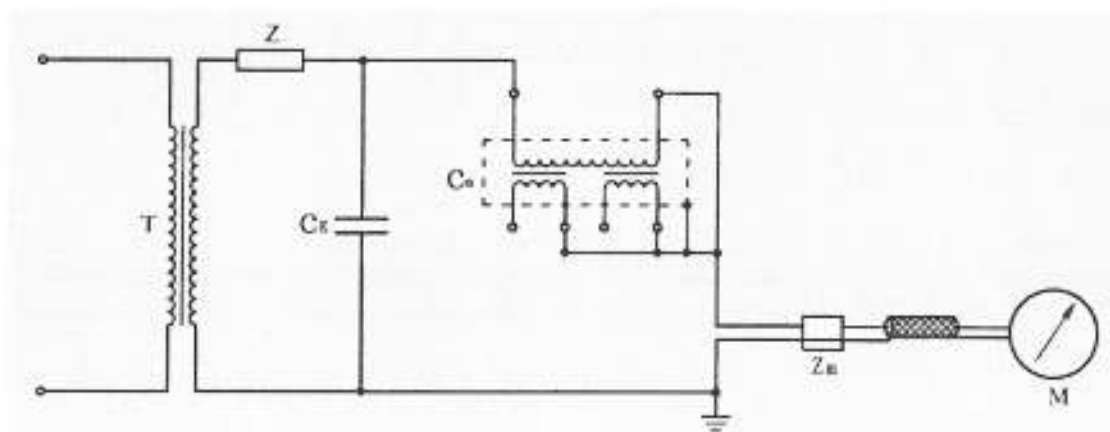

- T —Testing transformer
 C_o —Object
 C_x —Coupling capacitor
 M —Partial discharge detector
 Z_u —Impedance
 Z —filter (if C_x refers to capacitance of testing transformer, Filter is unnecessary)

Appendix No.L Photograph of semblance



 广东省名牌产品
 广东省著名商标

电压互感器

型号 JSQXF-145K 额定频率 50 Hz 标准 GB1207-2006
 额定绝缘水平 145/275/650 kV 温度 -25~40℃
 额定电压因数 1.2Un, 连续; 1.5, 30s 户内 三相
 SF₆气体额定压力 0.50 MPa SF₆气体最低运行压力 0.45 MPa

变比 kV	端子	准确度	负荷 VA	额定输出 VA
132/√3:110/√3	1a 1n	0.5	100	
132/√3:110/√3	2a 2n	3P	100	1000

SF₆气体重量 14 kg 总重量 480 kg 运输压力 0.02 MPa
 出厂编号 V1310132060 制造日期 2013 年 10 月

广东四会互感器厂有限公司

地址: 广东省四会市东城街道富华路9号
 电话: +86-758-3231108

电气原理图
