



China Electric Power Research Institute
Power Industry Quality Inspection and Testing Center for
Electric Equipment and Instruments



EETC2016HG001J



中国认可
国际互认
检测
TESTING
CNAS L0699



Test Report

Address: NO. 143, Luoyu Road, Hongshan District, Wuhan,
Hubei Province.

Postcode: 430074

Tel: 400-656-5689

Fax: 86-27-5937-8488

Website: <http://www.epri.sgcc.com.cn>

NOTICE

- 1 This test report will enter into effect with exclusive test seals, a steel seal and anti-fake labels of EETC.
- 2 This report is legally made available accompany with tested, checked, verified and approved signatures.
- 3 Any objections in the report should be posed within 30 days once the report is received.
- 4 This report only takes responsibility to the test sample.
- 5 Report's authenticity can be confirmed via website or tel on the cover.



1 Client

Guangdong SiHui Instrument Transformer Works Co.,Ltd.

2 Sample Description

Name: Inductive voltage transformer

Type: JDQXF-220

Manufacturer: Guangdong SiHui Instrument Transformer Works Co.,Ltd.

Manufacture Date: Oct., 2015

Sample No./Details: V1402550081

3 Standards/Specifications

GB20840.1-2010 Instrument transformers-Part 1: General requirements

GB20840.3-2013 Instrument transformers-Part 3: Additional requirements for inductive voltage transformers

IEC61869-1:2007 Instrument transformers-Part 1: General requirements

IEC61869-3:2011 Instrument transformers-Part 3: Additional requirements for inductive voltage transformers

4 Test Category

Routine Test /Type Test/Special Test

5 Test Date

04 Jan. 2016 to 21 Jan. 2016

6 Conclusion

The inductive voltage transformer with the type of JDQXF-220 offered by Guangdong SiHui Instrument Transformer Works Co.,Ltd. meets the requirements of the corresponding items of the standards GB20840.1-2010,GB20840.3-2013,IEC61869-1:2007,IEC61869-3:2011.

Note 1: In the event of any difference in meanings of the text, the Chinese report shall take priority over the English version.

Note 2: (Period of validity: 5 years.)

Tested by: 刘翔 李德峰

Checked by: 刘翔

Verified by: 李德峰

Approved by: 李德峰

Date of issue: 2016-03-31

7 Inspection Items and Results

No.	Item	Requirements	Results	Evaluation
1	Verification of markings	The nameplate, sign, earthing terminal, terminal marking shall meet the requirements. The valve and the bursting plate shall be in good condition.	Meet the requirements	Pass
2	Power-frequency voltage withstand tests on secondary terminals	Applied voltage on winding-to-winding and winding-to-earth shall be 3kV/50Hz/60s	Test voltage: 3kV/50Hz/60s No flashover and breakdown occurred.	Pass
3	Power-frequency voltage withstand tests on primary terminals	Induced voltage between primary winding and earth shall be 460kV/150Hz/40s Applied voltage between earthed terminal of primary winding and earth shall be 5kV/50Hz/60s	Test voltage: 460kV/150Hz/40s No flashover and breakdown occurred. Atmosphere correction factor: $K_a=1.010$ Test voltage: 5kV/50Hz/60s No flashover and breakdown occurred.	Pass
4	Partial discharge measurement	Test frequency: 150 Hz Pre-stress voltage: 460 kV Test voltage: 252 kV Maximum permissible PD level: 10 pC Test voltage: 174.5 kV Maximum permissible PD level: 5 pC	Test frequency: 150 Hz Pre-stress voltage: 460 kV Test voltage: 252 kV PD level: 6 pC Test voltage: 175 kV PD level: 2 pC	Pass
5	Measurement of excitation characteristic	Exciting current shall be measured at 0.2, 0.5, 0.8, 1.0, 1.2 and 1.5 times of rated secondary voltage respectively.	Details are shown in item 2.5	---
6	Tests for accuracy	The errors of the secondary windings shall meet the requirements of accuracy classes 0.2/3P/3P.	Meet the requirements	Pass
7	Temperature-rise test	The voltage of $1.0U_{pr}$ is applied on primary winding with the secondary windings loaded with the thermal limiting burden. The temperature-rise of windings shall not exceed 75K.	AN: 12 K 1a1n: 23 K	Pass
		The voltage of $1.2U_{pr}$ is applied on primary winding with the secondary windings loaded with the maximum rated burden. The temperature-rise of windings shall not exceed 75K.	AN: 6 K 1a1n: 13 K 2a2n: 12 K	Pass

No.	Item	Requirements	Results	Evaluation
7	Temperature-rise test	The voltage of $1.5U_{pr}$ is applied on primary winding for 30s beginning from the cold condition with the secondary windings loaded with the rated burden. The temperature-rise of windings shall not exceed 10K.	AN: 0.6 K 1a1n: 0.5 K 2a2n: 0.6 K dadn: 0.8 K	Pass
8	Impulse voltage test on primary terminals(Lightning and chopped impulse voltage test on primary terminals)	Standard LI: $1050kV/\pm 15$ Waveform: $1.2/50\mu s$ Standard LI-chopped: $1208kV/-2$ Waveform: $(2\sim 5)\mu s$	1038kV~1059kV ± 15 1199kV~1205kV -2 No flashover and breakdown occurred.	Pass
9	Wet test for outdoor type transformers	In wet condition, induced voltage between primary winding and earth shall be 460kV/150Hz/40s	Test voltage:460kV/150Hz/40s No flashover and breakdown occurred. Atmosphere correction factor: $K_t=1.010$ Water conductivity: $103\mu S/cm$ Vertical precipitation:1.3mm/min Horizontal precipitation: 1.2mm/min	Pass
10	Short-circuit withstand capability test	The rated voltage 57.7V is applied on secondary winding for 1.0s with primary winding connected to earth. There shall be no electrical and mechanical damage.	1a1n Test voltage: 57.7 V Test current: 787 A Duration: 1.01 s Note: The primary winding is of copper, and the calculated current density is $14A/mm^2$. The secondary winding is of copper, and the calculated current density is $86A/mm^2$.	Pass
11	Power-frequency voltage withstand tests on secondary terminals (retrial)	Applied voltage on winding-to-winding and winding-to-earth shall be 2.7kV/50Hz/60s.	Test voltage: 2.7kV/50Hz/60s No flashover and breakdown occurred.	Pass
12	Power-frequency voltage withstand tests on primary terminals (retrial)	Induced voltage between primary winding and earth shall be 414kV/150Hz/40s Applied voltage between earthed terminal of primary winding and earth shall be 4.5kV/50Hz/60s	Test voltage: 414kV/150Hz/40s No flashover and breakdown occurred. Test voltage: 4.5kV/50Hz/60s No flashover and breakdown occurred.	Pass
13	Partial discharge measurement (retrial)	Test frequency: 150 Hz Pre-stress voltage: 414 kV Test voltage: 252 kV Maximum permissible PD level: 10 pC Test voltage: 174.5 kV Maximum permissible PD level: 5 pC	Test frequency: 150 Hz Pre-stress voltage: 414 kV Test voltage: 252 kV PD level: 5 pC Test voltage: 175 kV PD level: 2 pC	Pass

No.	Item	Requirements	Results	Evaluation
14	Measurement of excitation characteristic (retrial)	Exciting current shall be measured at rated secondary voltage.	IaIn: 15.7A	---
15	Tests for accuracy (retrial)	The errors of the secondary winding shall meet the requirements of accuracy class 0.2.	Meet the requirements.	Pass
16	Electromagnetic Compatibility (EMC) tests (RIV test)	The radio interference voltage shall not exceed $2500 \mu V$ at $1.1U_n/\sqrt{3}$.	Test voltage: 160kV/50Hz Radio interference voltage (0.5MHz): <1210 μ V	Pass
17	Transmitted overvoltage test	A low voltage impulse (U_1) ($T_1=0.5\mu s \pm 20\%$, $T_2 \geq 50\mu s$) shall be applied between one of the primary terminals and earth. The transmitted overvoltage shall not exceed 1.6kV.	Transmitted overvoltage: 245V~249V.	Pass
18	Mechanical tests	The test load shall be applied on primary terminal for at least 60s. There shall be no evidence of damage (deformation, rupture or leakage).	Horizontal: 1.5kN 60s. Vertical: 1.5kN 60s. There is no evidence of damage (deformation, rupture or leakage).	Pass
19	Enclosure tightness test at ambient temperature	The relative leakage rate (F_{rel}) shall not exceed 0.5% per year at rated filling pressure.	<0.1%	Pass
20	Gas dew point test	The dew-point is not higher than $-38.6^\circ C$ for a measurement at $20^\circ C$. The water content of gas shall be less than 150 μ L/L	The dew-point : $-45.3^\circ C$ The water content of gas : 69 μ L/L	Pass
21	Verification of the degree of protection by enclosures	The degree of protection of low-voltage control and/or auxiliary enclosures for outdoor instrument transformers is IP54. The level of protection against effects of mechanical impacts is impact level IK07.	Meet the requirements. Note: The test was performed on another secondary terminal box of the same type offered by the client.	Pass

No.	Item	Requirements	Results	Evaluation
22	Pressure test for the enclosure	Welded aluminum enclosure shall withstand $(3.5/0.7) \times$ "the design pressure" for 1min, no broken or permanent deformation. Composite hollow insulator shall withstand $4.0 \times$ MSP for 5min, no visible damage.	Welded aluminum enclosure: Test Pressure:3.5MPa Duration:1 min No broken and no permanent deformation. Composite hollow insulator: Test Pressure:2.8MPa Duration:5min No visible damage. Note: 1: The design pressure is 0.7MPa, and the maximum service pressure (MSP) is 0.7MPa. 2: The test was performed on another welded aluminum enclosure and composite hollow insulator of the same type offered by the client.	Pass

Note: 1. The tests of 4~9, 11~17 items were performed in the minimum functional pressure of 0.60MPa (absolute pressure). The tests of 10, 18~20 items were performed in the rated filling pressure of 0.65MPa (absolute pressure).

2. According to the client's request, Test voltage of power-frequency short-duration withstand test on primary terminals was 190kV/5min, no flashover and breakdown occurred.

1 Identification of the tested object

1.1 Parameters

Name: Inductive voltage transformer

Type: JDQXF-220

Sample No.: V1402550081

Manufacturer: Guangdong SiHui Instrument Transformer Works Co.,Ltd.

Sampling way: Offer by client

Date of Manufacture: Oct., 2015

Main parameters provided by the manufacturer:

Highest voltage for equipment(U_m)	252 kV	Rated primary voltage(U_{pr})	$220/\sqrt{3}$ kV
Equipment category	Outdoor	Rated frequency	50Hz
Rated filling pressure	0.65MPa	Minimum functional pressure	0.60MPa
Temperature categories	-25 °C/+40 °C	Altitude	≤ 1000 m
Rated transformation ratio	$220/\sqrt{3} / 0.1/\sqrt{3} / 0.1/\sqrt{3} / 0.1$ kV		
Rated insulation level	252/460/1050 kV		
Rated voltage factor , rated time	$1.5U_{ps}30s$		
Secondary winding/ Accuracy class	1a1n/0.2	2a2n/3P	3a3n/3P
Rated burden (VA) /Power factor	100/0.8	50/0.8	300/0.8
Rated thermal limiting output(VA)	/	2000	/

1.2 Drawings

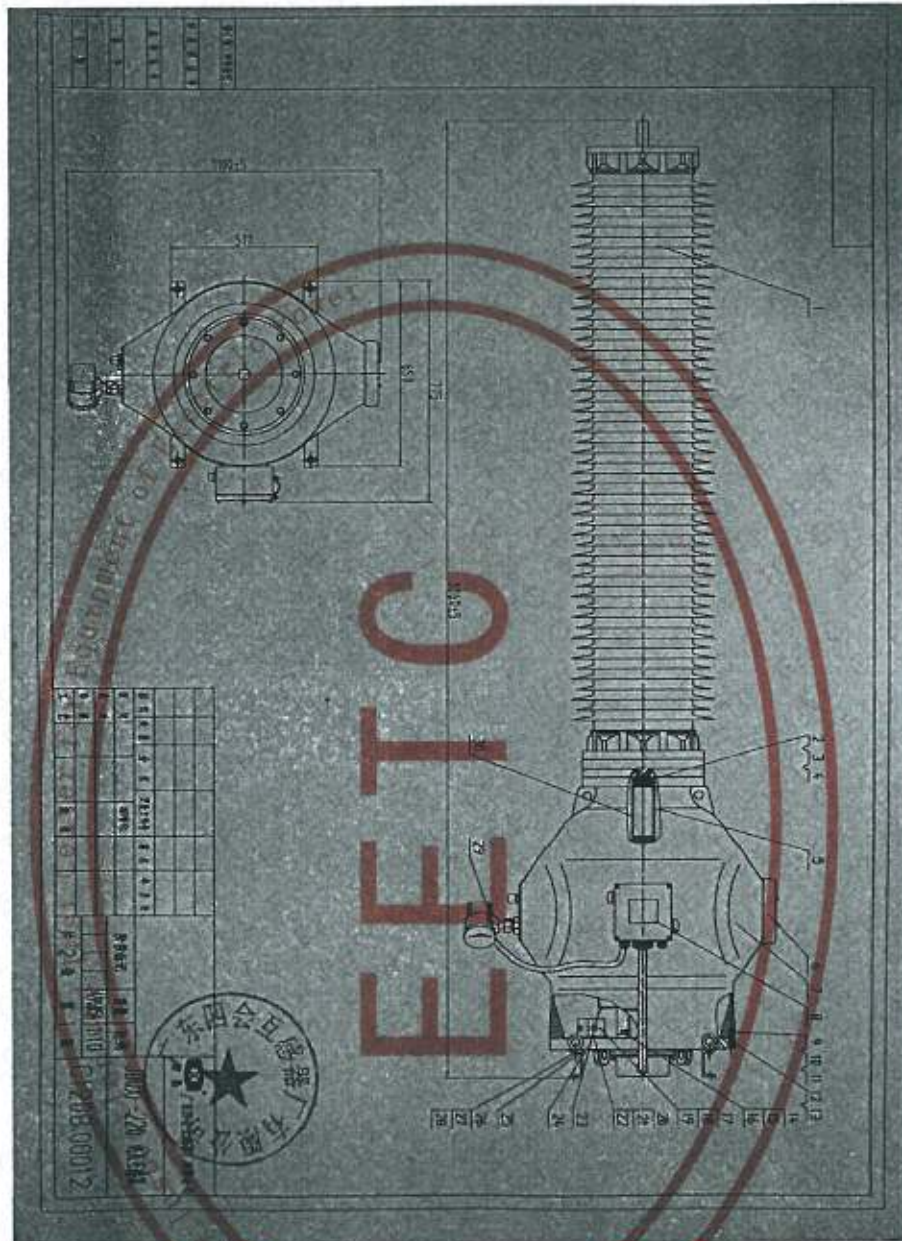

1.3 Statement

图样和资料目录真实代表所送试品的声明

本公司向电力工业电气设备质量检验测试中心提交的型号为 (JDQXF-220) 互感器的图样、资料目录与所送试样机一致, 能真实代表所送试样机。

序号	目录	名称	编号/代码
1	总装图	JDQXF-220 电压互感器	C1208.00012
2	绝缘子详图	245kV 复合空心绝缘子	L5101.00081
3	一、二次端子详图	法兰/端子装配	L2205.00166 B1100.00494
4	产品铭牌图	铭牌	L6000.02907
5	使用说明书	使用说明书	C1207.00158SM
6	产品技术条件/企标	技术条件	C1207.00158JT
7	工厂明示的关键材料/部件清单	JDQXF-220 关键材料部件清单	/
8	制作工艺文件及设计文件目录	高压电磁式电压互感器各工序的生产作业指导书目录	C1208.00012ML
8.1	一、二次绕组绕制包扎工艺文件	高压电磁式电压互感器高压绕组绕制作业指导书 高压电磁式电压互感器低压绕组绕制作业指导书	GY-005-2013 GY-004-2013
8.2	主绝缘制作	VT 高压线圈固化作业指导书	GY-001-2013
8.3	器身干燥工艺文件	高压电磁式电压互感器器身装配作业指导书	GY-001-2014
8.4	产品密封工艺文件	壳体试漏作业指导书	GY-002-2013
8.5	产品装配工艺文件	高压电磁式电压互感器总装配作业指导书	GY-001-2014

1.3.1 The testing laboratory has checked that the drawings and other data submitted by the manufacturer can adequately represent the essential details and parts of the equipment to be tested, but isn't responsible for the accuracy of the detailed information.

1.3.2 Before all the tests, the test object offered by the client is a new, clean inductive voltage transformer, including frame and all the other parts as in normal operation.

1.3.3 The test object is a single phase inductive voltage transformer with outer insulation of silicon rubber bushing. The creepage distance is 8.35m and the arcing distance is 2.02m.

1.3.4 Confirmed date of test object: 04 Jan. 2016

1.3.5 Client representative: Lu Jianyi

1.4 Photographs of test object



 广东省名牌产品 **电压互感器** 
 广东省著名商标 粤制 00000724号

型号	JDQXF-220	额定频率	50	Hz
额定绝缘水平	252/460/1050	kV	工作温度	-25 - 40 °C
额定电压	1.2Un, 连续; 1.5, 30s		海拔高度	≤1000 m
爬电比距	25	mm/kV	绝缘等级	E
SF ₆ 额定压力 / 最低压力 (20°C)	0.65 / 0.60 MPa			
变比 kV:V	端子	准确级	额定输出 VA	极限输出 VA
220/√3:100/√3	1a-1n	0.2	100	
220/√3:100/√3	2a-2n	3P	50	2000
220/√3:100	da-dn	3P	300	
SF ₆ 气体重量	14	kg	总重量	490 kg
标准	GB 20840.3-2013		运输压力	0.02 MPa
			出厂编号	V1402550081
			制造日期	2015 年 10 月

地址: 广东省四会市东城街道富华路8号
 电话: 0758-3231108
广东四会互感器厂有限公司

2 Test items and results

2.1 Verification of markings

2.1.1 The main test device

No.	Name	Type/ Specification	Serial No.	Uncertainty / Accuracy class / Maximum Permissible Error	Valid date
1	Transformer calibrator	HEF-H	# KI020 (YQ320)	2	2017.02.24

2.1.2 Reference standard requirement

The nameplate and the mark of terminals shall meet the requirements. The valve and the bursting plate shall be in good condition.

2.1.3 Data

The nameplate, sign, earthing terminal, terminal marking meet the requirements. The valve and the bursting plate are in good condition.

2.1.4 Test result

The test object passed the tests.

2.2 Power-frequency voltage withstand tests on secondary terminals

2.2.1 The main test device

No.	Name	Type/ Specification	Serial No.	Uncertainty / Accuracy class / Maximum Permissible Error	Valid date
1	Equipment for secondary voltage withstand tests	HZSY-S	#6120611 (SB210)	3	2016.10.08

2.2.2 Reference standard requirement

The test voltage of 3kV(50Hz) shall be applied for 60s between the short-circuited terminals of each winding and earth in turn. No flashover and breakdown occur.

2.2.3 Data

The test voltage of 3kV(50Hz) was applied for 60s between the short-circuited terminals of each winding and earth in turn. No flashover and breakdown occurred.

2.2.4 Test result

The test object passed the tests.

2.3 Power-frequency voltage withstand tests on primary terminals

2.3.1 The main test device

No.	Name	Type/ Specification	Serial No.	Uncertainty / Accuracy class / Maximum Permissible Error	Valid date
1	Series resonance measuring system	TRF1200-0.002	#111030 (YQ220)	3	2017.12.18
2	Series resonance testing device	YDGK-1200/3×400	#111023 (SB220)	/	2017.01.26
3	Equipment for secondary voltage withstand tests	HZSY-S	#6120611 (SB210)	3	2016.10.08

2.3.2 Reference standard requirement

The induced voltage of 460kV (150Hz) shall be applied between primary winding and earth for 40s. No flashover and breakdown occur.

The test voltage of 5kV(50Hz) shall be applied between earthed terminal of primary winding and earth for 60s. No flashover and breakdown occur.

2.3.3 Data

Ambient temperature: 8 ℃ Relative humidity: 72% Ambient air pressure: 102.6kPa

The induced voltage of 460kV (150Hz) was applied between primary winding and earth for 40s. No flashover and breakdown occurred.

The test voltage of 5kV(50Hz) was applied between earthed terminal of primary winding and earth for 60s. No flashover and breakdown occurred.

2.3.4 Test result

The test object passed the tests.

2.4 Partial discharge measurement

2.4.1 The main test device

No.	Name	Type/ Specification	Serial No.	Uncertainty / Accuracy class / Maximum Permissible Error	Valid date
1	Partial discharge detector	JFD-251	#20071203 (YQ380)	10	2017.03.01
2	Series resonance measuring system	TRF1200-0.002	#111030 (YQ220)	3	2017.12.18
3	Series resonance testing device	YDGK-1200/3×400	#111023 (SB220)	/	2017.01.26

2.4.2 Reference standard requirement

Pre-stress voltage: 460kV, Test frequency: 150Hz

Test voltage: 252 kV, Maximum permissible PD level: 10 pC

Test voltage: 174.5kV, Maximum permissible PD level: 5 pC

2.4.3 Data

Ambient temperature:8℃ Relative humidity:72%

Test frequency (Hz)	150	
Pre-stress voltage (kV)	460	
Test voltage (kV)	252	175
PD level(pC)	6	2

2.4.4 Test result

The test object passed the tests.

2.5 Measurement of excitation characteristic**2.5.1 The main test device**

No.	Name	Type/ Specification	Serial No.	Uncertainty / Accuracy class / Maximum Permissible Error	Valid date
1	V-A characteristic tester	ZZFA-IV	#10088 (YQ408)	0.2	2017.01.05

2.5.1 Reference standard requirement

Exciting current was measured at 0.2, 0.5, 0.8, 1.0, 1.2 and 1.5 times of rated secondary voltage respectively.

2.5.2 Data

Ambient temperature:8℃ Relative humidity:72%

Percentage of rated secondary voltage(%)		20	50	80	100	120	150
Test voltage (V)		11.5	28.9	46.2	57.7	69.9	86.6
I _{aln}	No-load current (A)	3.14	7.52	12.4	15.6	17.6	18.4
	No-load loss (W)	/	/	/	69.3	/	/

2.5.3 Test result

The test object was both in good conditions before and after the tests.

2.6 Tests for accuracy

2.6.1 Test circuit diagram

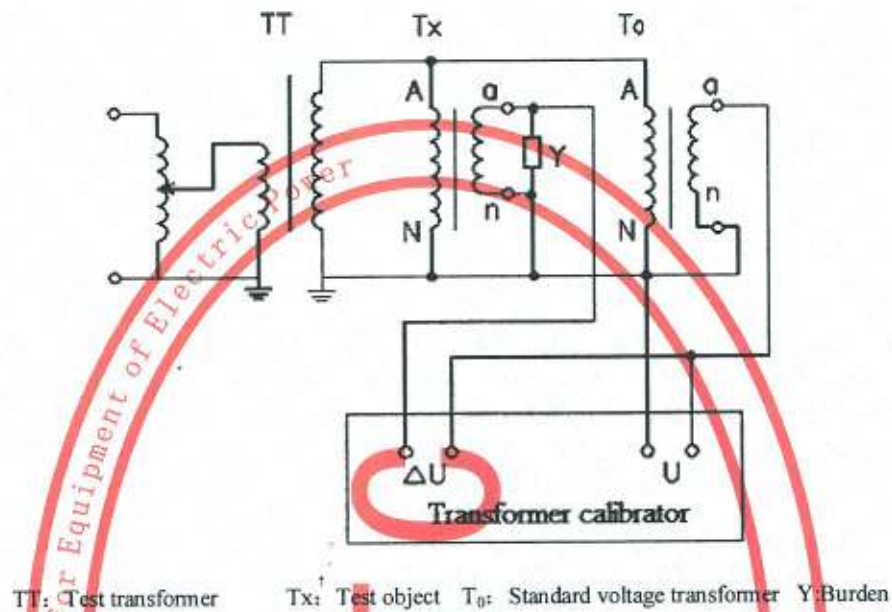

2.6.2 The main test device

No.	Name	Type/Specification	Serial No.	Uncertainty / Accuracy class / Maximum Permissible Error	Valid date
1	Standard voltage transformer	HJ-220	#03002 (YQ369)	0.02	2016.10.27
2	Transformer calibrator	HEF-H	#KI020 (YQ320)	2	2017.02.26

2.6.3 Reference standard requirement

The errors of the secondary windings shall meet the requirements of accuracy classes 0.2/3P/3P.

2.6.4 Data

Ambient temperature: 8°C Relative humidity: 72%

Secondary windings	Accuracy class	U_{pr} %	Ratio error (%)	Phase displacement (°)	Burden(VA) $\cos\phi=0.8$			Ratio error (%)	Phase displacement (°)	Burden(VA) $\cos\phi=0.8$		
					1a 1n	2a 2n	da dn			1a 1n	2a 2n	da dn
1a 1n	0.2	80	-0.10	-2	100	50	/	+0.16	0	25	0	/
		100	-0.10	-2				+0.14	0			
		120	-0.16	-2				+0.08	0			

Secondary windings	Accuracy class	U_{pr} %	Ratio error (%)	Phase displacement (')	Burden(VA) $\cos\phi=0.8$			Ratio error (%)	Phase displacement (')	Burden(VA) $\cos\phi=0.8$		
					1a 1n	2a 2n	da dn			1a 1n	2a 2n	da dn
2a2n	3P	2	+0.02	-4	100	50	0	+0.24	0	0	12.5	0
		5	+0.02	-4				+0.24	0			
		100	+0.02	-4				+0.24	0			
		150	-0.24	-2				100	50			
dadn	3P	2	-0.02	-6	100	50	0	+0.16	0	0	0	0
		5	-0.02	-6				+0.16	0			
		100	-0.04	-6				+0.16	0			
		150	-0.06	-8				100	50			

2.6.5 Test result

The test object passed the tests.

2.7 Temperature-rise test

2.7.1 Test circuit diagram

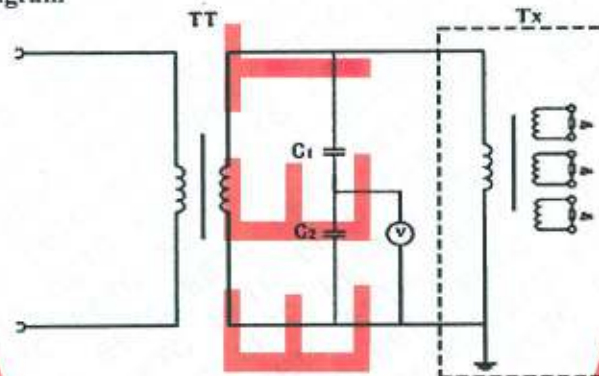

TT: Test transformer Tx: Test object C₁, C₂: High voltage divider Zn: Burden

2.7.2 The main test device

No.	Name	Type/ Specification	Serial No.	Uncertainty / Accuracy class / Maximum Permissible Error	Valid date
1	DC bridge	JY44B	#01124972 (YQ210)	0.5	2017.01.25
2	Series resonance measuring system	TRF1200-0.002	#111030 (YQ220)	3	2017.12.18
3	Series resonance testing device	YDGK-1200/3×400	#111023 (SB220)	/	2017.01.26

2.7.3 Reference standard requirement

1) The voltage of $1.0U_{pr}$ is applied on primary winding with the secondary winding (1a1n) loaded with the thermal limiting burden, the temperature-rise of windings shall not exceed 75K.

- 2) The voltage of $1.2U_{pr}$ is applied on primary winding with the secondary windings loaded with the maximum rated burden , the temperature-rise of windings shall not exceed 75K.
- 3) The voltage of $1.5 U_{pr}$ (30s) is applied on primary winding beginning from the cold condition with the secondary windings loaded with the maximum rated burden, the temperature-rise of windings shall not exceed 10K.

2.7.4 Data

Winding	AN(kΩ)	1a1n(mΩ)	2a2n(mΩ)	dadn(mΩ)	Ambient temperature(°C)
Resistance at ambient temperature	28.66	42.37	41.62	116.0	10

The temperature-rise are shown as follow:

Winding Voltage	AN(K)	1a1n(K)	2a2n(K)	dadn(K)	Ambient temperature(°C)
$1.0U_{pr}$	12	/	23	/	10
$1.2U_{pr}$	6	13	12	/	10
$1.9U_{pr}$	0.6	0.5	0.6	0.8	10

Typical graphs of temperature-rise

$1.0U_{pr}$

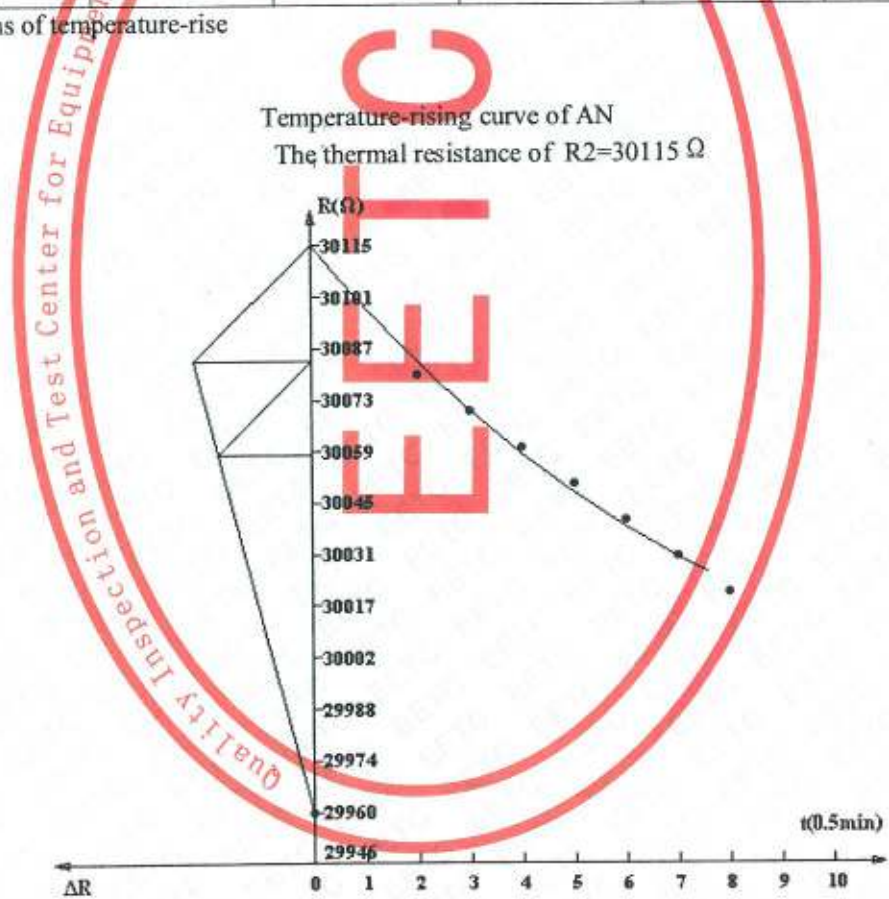

Temperature-rising curve of 2a2n
 The thermal resistance of $R_2=0.045434 \Omega$

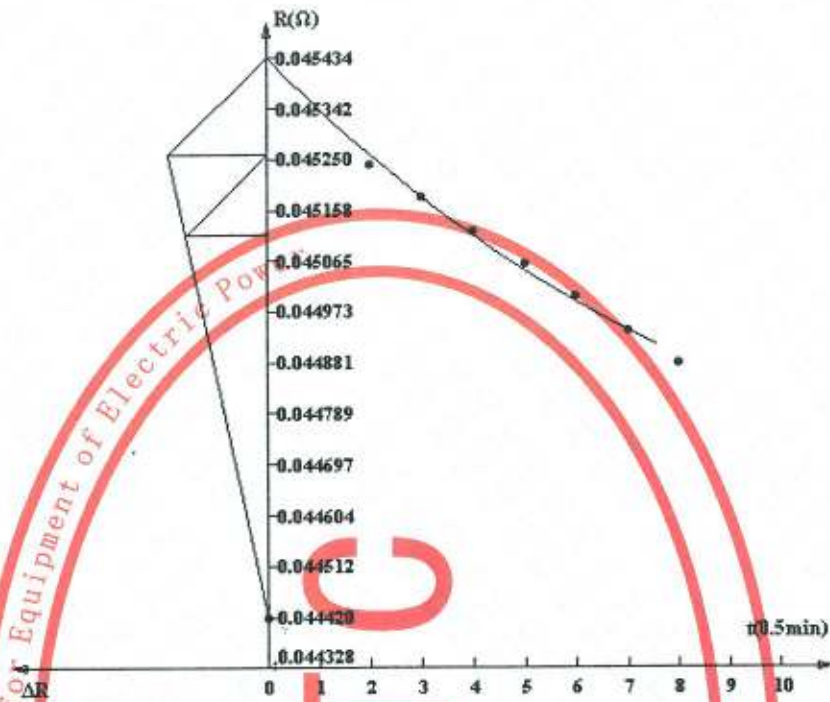

2.7.5 Test result
 The test object passed the tests.

2.8 Impulse voltage test on primary terminals (Lightning and chopped impulse voltage test on primary terminals)

2.8.1 Test circuit diagram

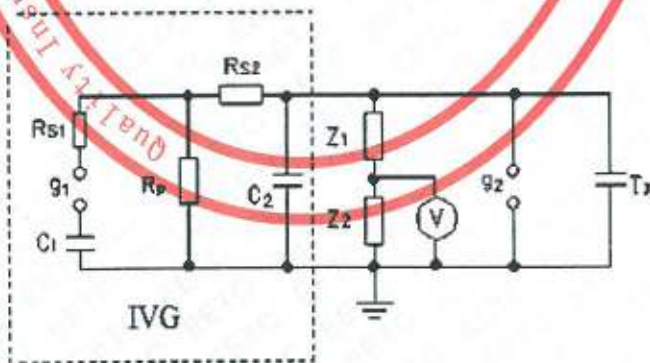

IVG: Impulse voltage generator Z_1, Z_2 : High voltage divider g_2 : Chopped device T_x : Test object

2.8.2 The main test device

No.	Name	Type/ Specification	Serial No.	Uncertainty / Accuracy class / Maximum Permissible Error	Valid date
1	Impulse voltage generator	4000kV, 300kJ	#170200010 03 (SB202)	/	2017.05.06
3	Impulse voltage measuring system	3000kV	#550264 (YQ212)	3	2017.08.05

2.8.3 Reference standard requirement

The test object shall be subjected to 15 full lighting impulses of positive and negative polarity at 1050kV(peak value),2 chopped lighting impulses of negative polarity at 1208kV(peak value).

No disruptive discharge on non-self restoring insulation shall occur and the number of disruptive discharge shall not exceed two for each series. No evidence of insulation failure shall be detected.

2.8.4 Date

Ambient temperature:10℃ Relative humidity: 69%

No.	Voltage polarity	Test voltage (peak)(kV)	Chopped time (μ s)	Waveform No.	Result
1	Pos.LI	643	/	1	Pass
2	Pos.LI	1038	/	2	Pass
3	Pos.LI	1052	/	3	Pass
4	Pos.LI	1046	/	4	Pass
5	Pos.LI	1045	/	5	Pass
6	Pos.LI	1048	/	6	Pass
7	Pos.LI	1049	/	7	Pass
8	Pos.LI	1048	/	8	Pass
9	Pos.LI	1052	/	9	Pass
10	Pos.LI	1051	/	10	Pass
11	Pos.LI	1051	/	11	Pass
12	Pos.LI	1050	/	12	Pass
13	Pos.LI	1050	/	13	Pass
14	Pos.LI	1050	/	14	Pass
15	Pos.LI	1050	/	15	Pass
16	Pos.LI	1051	/	16	Pass
17	Neg.LI	644	/	17	Pass
18	Neg.LI	1050	/	18	Pass
19	Neg.LI-chopped	709	3.5	19	Pass
20	Neg.LI-chopped	1205	3.5	20	Pass
21	Neg.LI-chopped	1199	3.5	21	Pass
22	Neg.LI	1058	/	22	Pass

No.	Voltage polarity	Test voltage (peak)(kV)	Chopped time (μs)	Waveform No.	Result
23	Neg.LI	1058	/	23	Pass
24	Neg.LI	1059	/	24	Pass
25	Neg.LI	1059	/	25	Pass
26	Neg.LI	1059	/	26	Pass
27	Neg.LI	1059	/	27	Pass
28	Neg.LI	1059	/	28	Pass
29	Neg.LI	1059	/	29	Pass
30	Neg.LI	1059	/	30	Pass
31	Neg.LI	1047	/	31	Pass
32	Neg.LI	1046	/	32	Pass
33	Neg.LI	1053	/	33	Pass
34	Neg.LI	1054	/	34	Pass
35	Neg.LI	1051	/	35	Pass

waveform:

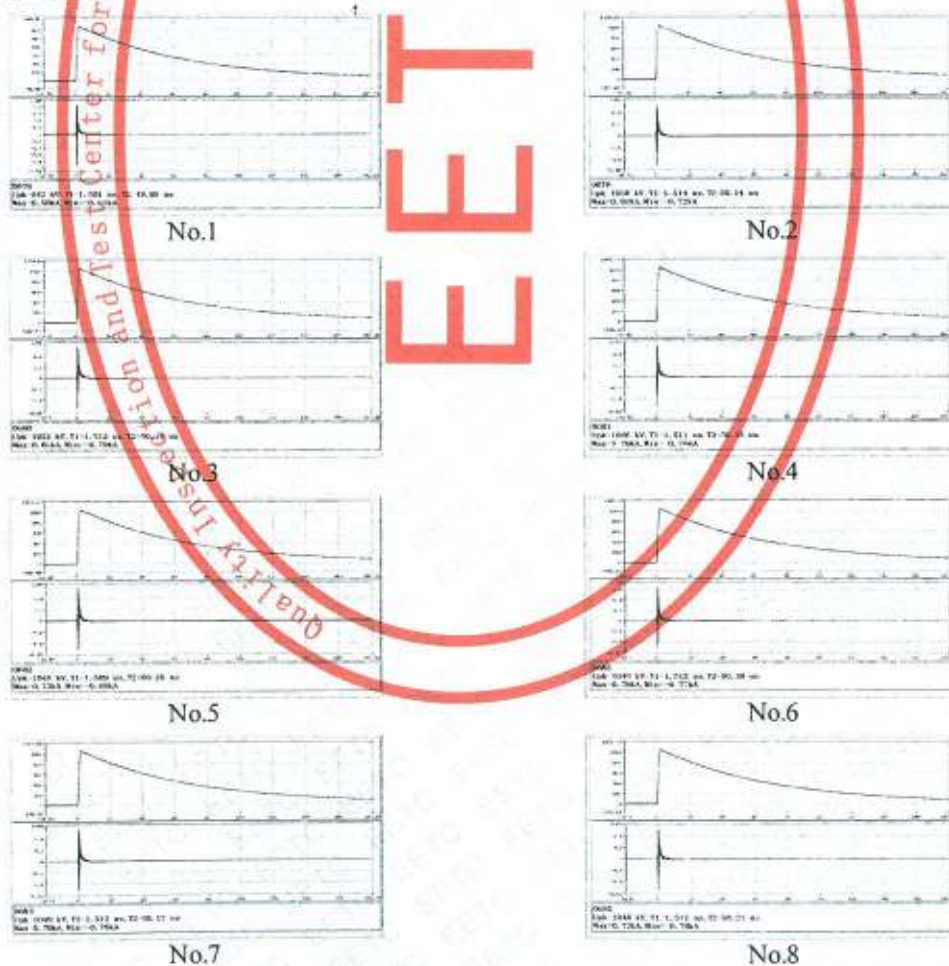

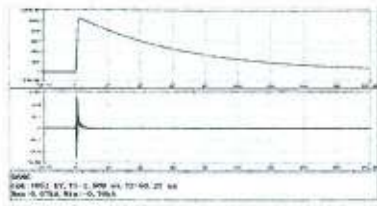

No.9

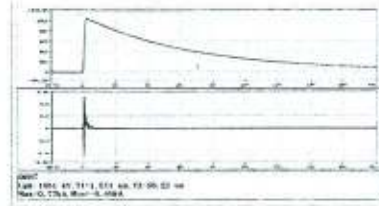

No.10

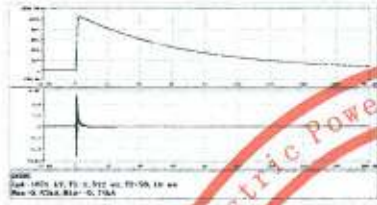

No.11

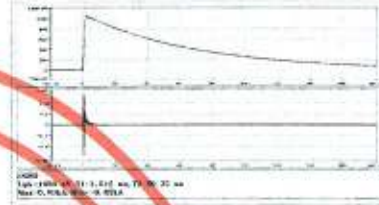

No.12

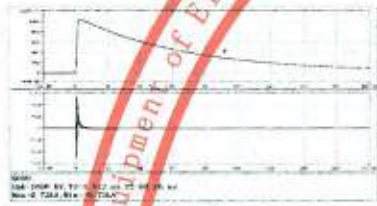

No.13

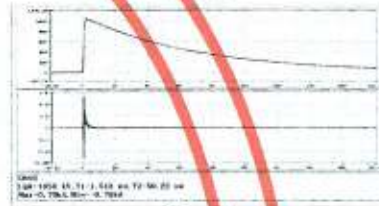

No.14

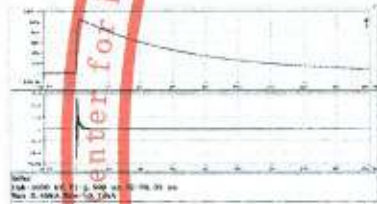

No.15

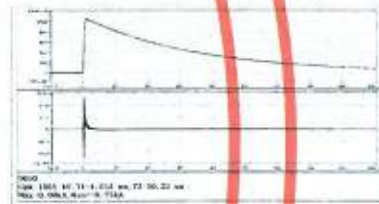

No.16



No.17

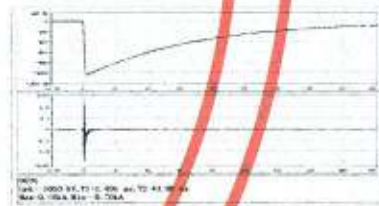

No.18

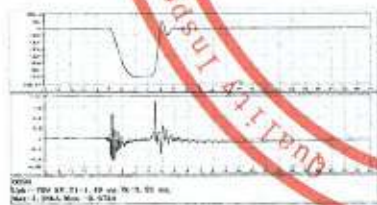

No.19

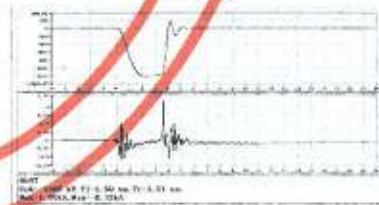

No.20

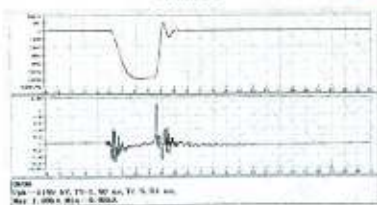

No.21

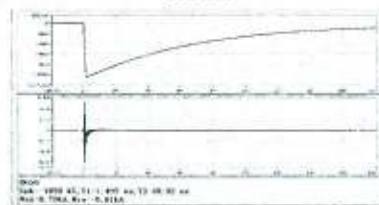

No.22

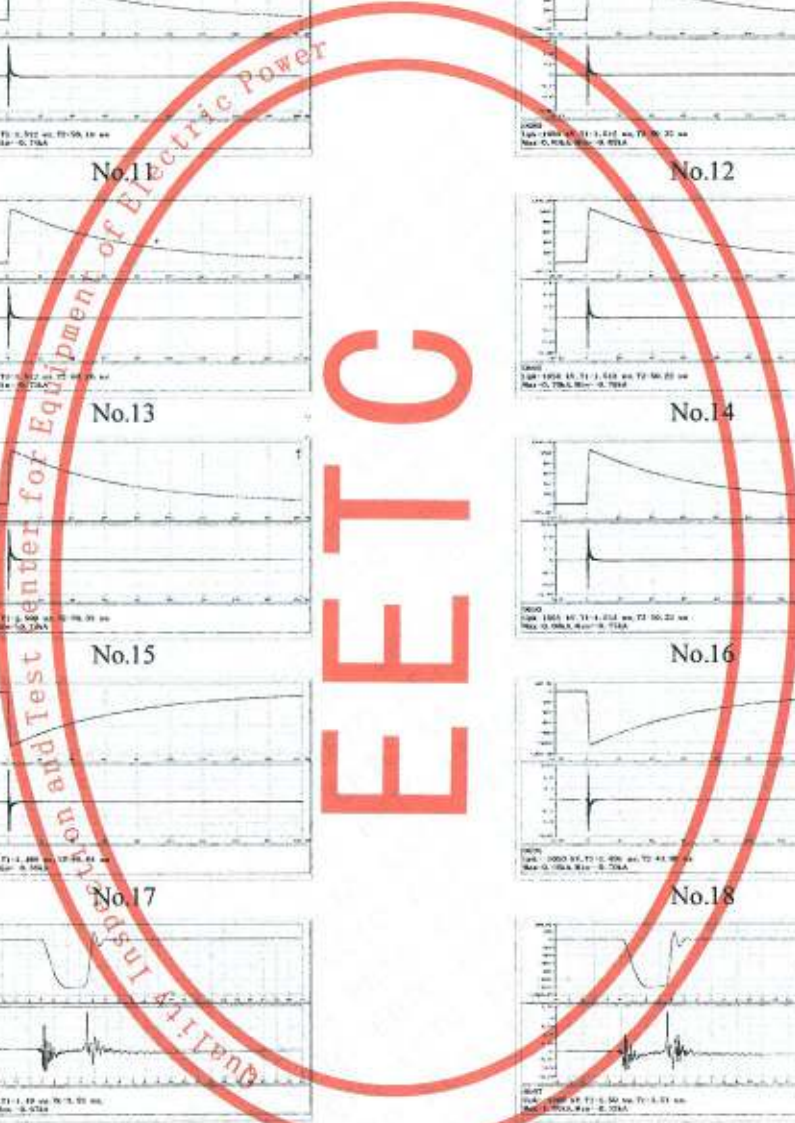

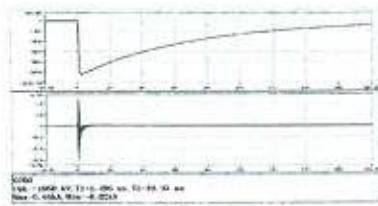

No.23

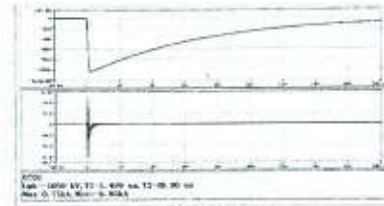

No.24

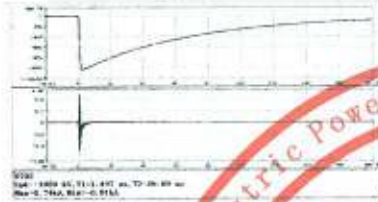

No.25

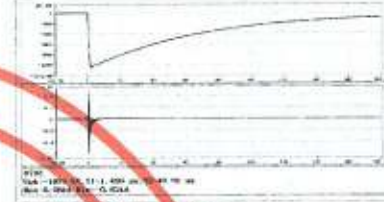

No.26



No.27

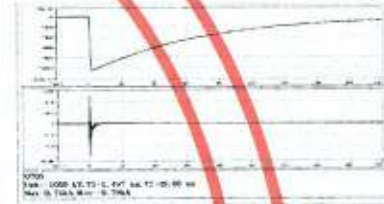

No.28

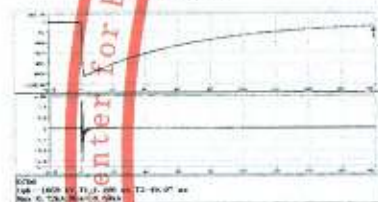

No.29

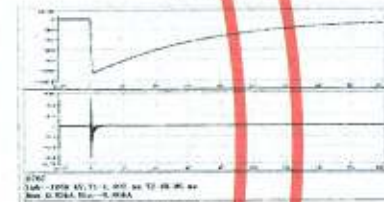

No.30

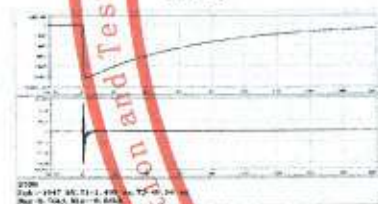

No.31

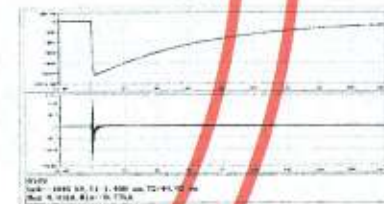

No.32

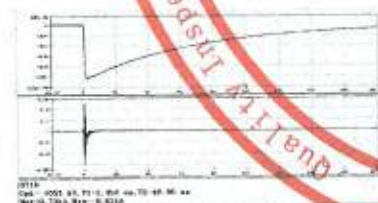

No.33

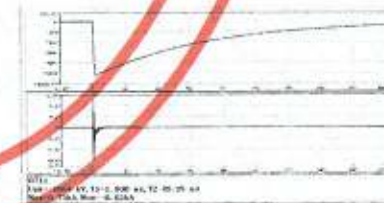

No.34

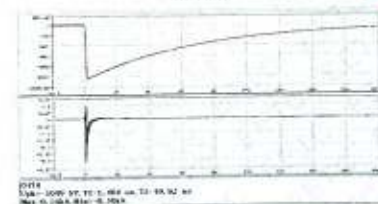

No.35

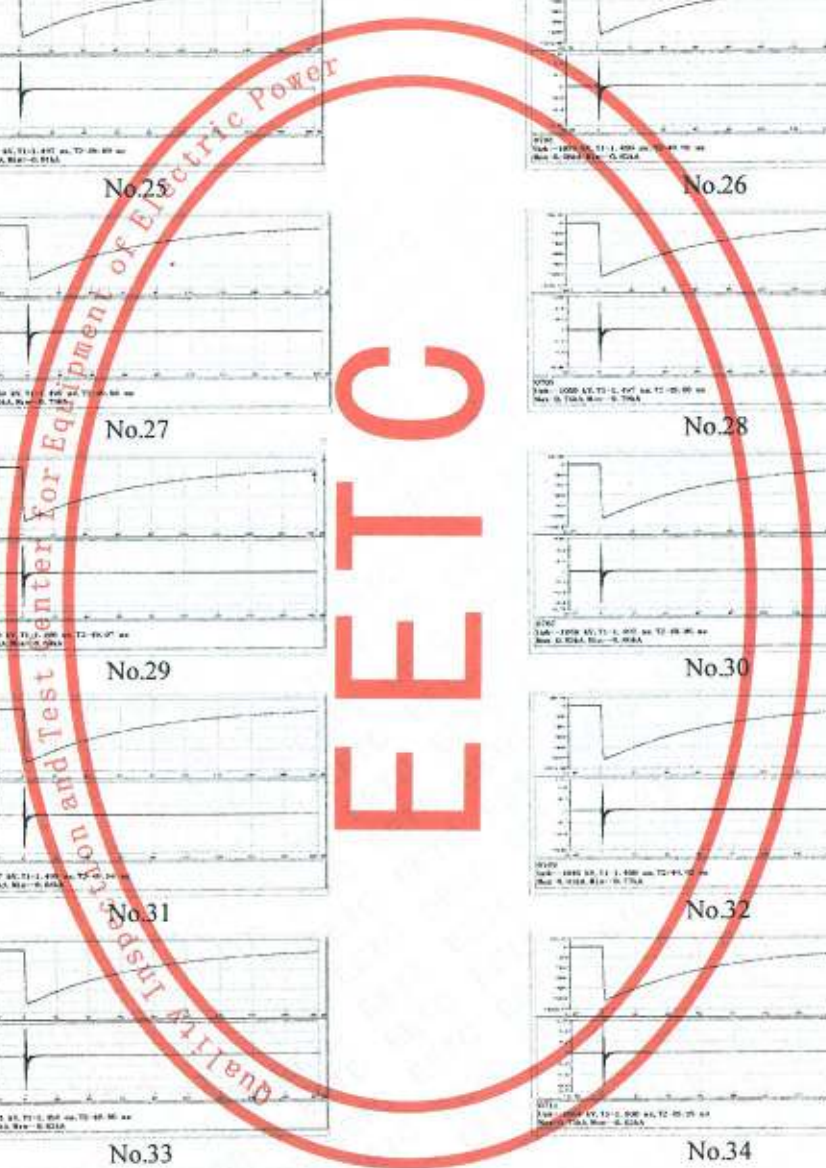

2.8.5 Test result

The test object passed the tests.

2.9 Wet test for outdoor type transformers

2.9.1 Test circuit diagram

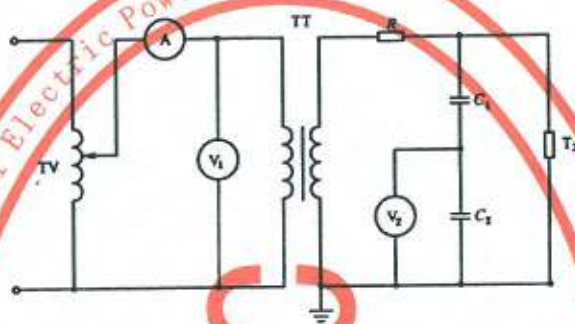

TV: Voltage regulator TT: Test transformer C_1, C_2 : High voltage divider T_x : Test object

2.9.2 The main test device

No.	Name	Serial No.	Type/ Specification	Uncertainty / Accuracy class / Maximum Permissible Error	Valid date
1	Series resonance measuring system	TRF1200-0.002	#111030 (YQ220)	3	2017.12.18
2	Series resonance testing device	YDGK-1200/3×400	#111023 (SB220)	/	2017.01.26
3	Conductivity Meter	DDS-307	#722014072713 (YQ307)	1.0	2017.01.25

2.9.3 Reference standard requirement

In wet condition, the induced voltage of 460kV (150Hz) shall be applied between primary winding and earth for 40s. No flashover and breakdown occur.

2.9.4 Data

Atmosphere correction factor: $K_f=1.010$ Water conductivity: $103\mu\text{S}/\text{cm}$
 Vertical precipitation: $1.3\text{mm}/\text{min}$ Horizontal precipitation: $1.2\text{mm}/\text{min}$
 Ambient temperature: 8°C Relative humidity: 72% Ambient air pressure: 102.6kPa

In wet condition, the induced voltage of 460kV (150Hz) was applied between primary winding and earth for 40s. No flashover and breakdown occurred.

2.9.5 Test result

The test object passed the tests.

2.10 Short circuit withstand capability test

2.10.1 Test circuit diagram

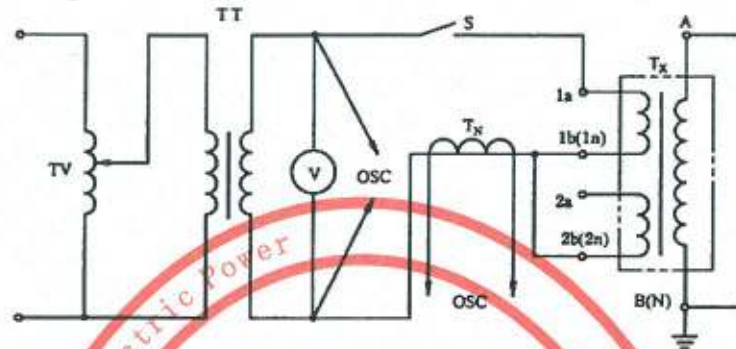

TV: Voltage regulator TT: Test transformer OSC: Oscillograph TA: Measuring current transformer Tx: Test object

2.10.2 The main test device

No.	Name	Type/ Specification	Serial No.	Uncertainty / Accuracy class / Maximum Permissible Error	Valid date
1	Measuring current transformer	HL23/8	#4613 (YQ341)	0.02	2016.11.24
2	Test transformer	SYG-1050/0.4	#99012078 (SB345)	/	2017.05.06
3	Oscilloscope	DPO3014B	#C012465 (YQ405)	±1%	2017.05.06

2.10.1 Reference standard requirement

The rated voltage 57.7V is applied on secondary winding for 1.0s with primary winding connected to earth. There shall be no electrical and mechanical damage.

2.10.2 Data

Ambient temperature: 9°C Relative humidity: 73%

Secondary winding	Secondary voltage (V)	Secondary short-circuit current (A)	Duration (s)
1a1n	57.7	787	1.01

Waveform of short-circuit test

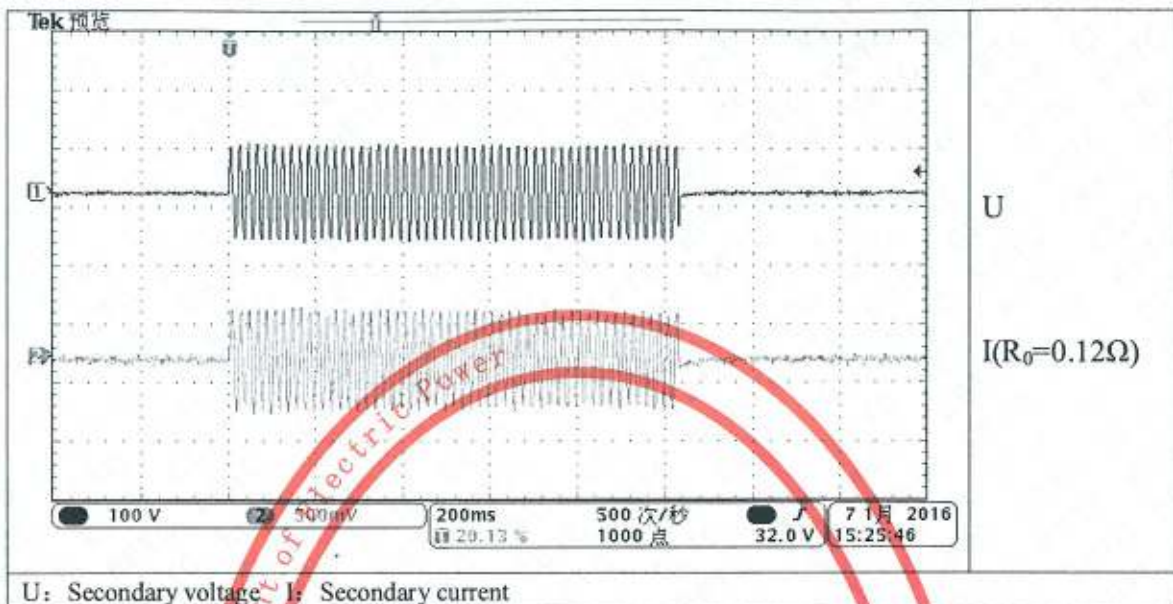

2.10.3 Test result

The test object was in good conditions before and after this test, no electrical and mechanical damage. The test object passed the tests.

2.11 Power-frequency voltage withstand tests on secondary terminals (retrial)

2.11.1 The main test device

No.	Name	Type/ Specification	Serial No.	Uncertainty / Accuracy class / Maximum Permissible Error	Valid date
1	Equipment for secondary voltage withstand tests	HZSY-S	#6120611 (SB210)	3	2016.10.08

2.11.2 Reference standard requirement

The test voltage of 2.7kV(50Hz) shall be applied for 60s between the short-circuited terminals of each winding and earth in turn. No flashover and breakdown occur.

2.11.3 Data

The test voltage of 2.7kV(50Hz) was applied for 60s between the short-circuited terminals of each winding and earth in turn. No flashover and breakdown occurred.

2.11.4 Test result

The test object passed the tests.

2.12 Power-frequency voltage withstand tests on primary terminals (retrial)

2.12.1 The main test device

No.	Name	Type/ Specification	Serial No.	Uncertainty / Accuracy class / Maximum Permissible Error	Valid date
1	Series resonance measuring system	TRF1200-0.002	#111030 (YQ220)	3	2017.12.18
2	Series resonance testing device	YDGK-1200/3×400	#111023 (SB220)	/	2017.01.26
3	Equipment for secondary voltage withstand tests	HZSY-S	#6120611 (SB210)	3	2016.10.08

2.12.2 Reference standard requirement

The induced voltage of 414kV (150Hz) shall be applied between primary winding and earth for 40s. No flashover and breakdown occur.

The test voltage of 4.5kV(50Hz) shall be applied between earthed terminal of primary winding and earth for 60s. No flashover and breakdown occur.

2.12.3 Data

Ambient temperature:8℃ Relative humidity:68%

The induced voltage of 414kV (150Hz) was applied between primary winding and earth for 40s. No flashover and breakdown occurred.

The test voltage of 4.5kV(50Hz) was applied between earthed terminal of primary winding and earth for 60s. No flashover and breakdown occurred.

2.12.4 Test result

The test object passed the tests.

2.13 Partial discharge measurement (retrial)

2.13.1 The main test device

No.	Name	Type/ Specification	Serial No.	Uncertainty / Accuracy class / Maximum Permissible Error	Valid date
1	Partial discharge detector	JFD-251	#20071203 (YQ380)	10	2017.03.01
2	Series resonance measuring system	TRF1200-0.002	#111030 (YQ220)	3	2017.12.18
3	Series resonance testing device	YDGK-1200/3×400	#111023 (SB220)	/	2017.01.26

2.13.1 Reference standard requirement

Pre-stress voltage: 414kV, Test frequency: 150Hz

Test voltage: 252kV, Maximum permissible PD level: 10pC

Test voltage: 174.5kV, Maximum permissible PD level: 5pC

2.13.2 Data

Ambient temperature:8℃ Relative humidity:68%

Test frequency (Hz)	150	
Pre-stress voltage (kV)	414	
Test voltage (kV)	252	175
PD level(pC)	5	2

2.13.3 Test result

The test object passed the tests.

2.14 Measurement of excitation characteristic (retrial)**2.14.1 The main test device**

No.	Name	Type/ Specification	Serial No.	Uncertainty / Accuracy class / Maximum Permissible Error	Valid date
1	V-A characteristic tester	ZZFA-IV	#10088 (YQ408)	0.2	2017.01.05

2.14.2 Reference standard requirement

Exciting current shall be measured at rated secondary voltage.

2.14.3 Data

Ambient temperature:8℃ Relative humidity:68%

Percentage of rated secondary voltage(%)		100
Test voltage (V)		57.7
I _{aIn}	No-load current (A)	15.7
	No-load loss (W)	69.5

2.14.4 Test result

The test object was in good conditions before and after this test.

2.15 Tests for accuracy (retrial)

2.15.1 Test circuit diagram

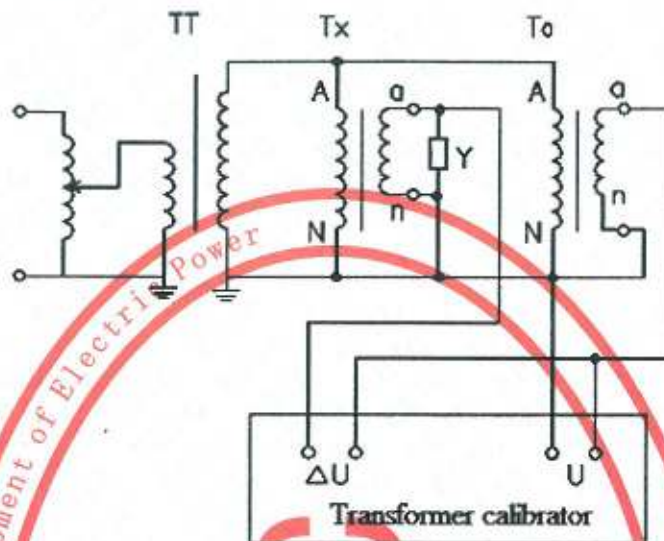

TT: Test transformer Tx: Test object To: Standard voltage transformer Y: Burden

2.15.2 The main test device

No.	Name	Type/ Specification	Serial No.	Uncertainty / Accuracy class / Maximum Permissible Error	Valid date
1	Standard voltage transformer	HJ-220	#03002 (YQ369)	0.02	2016.10.27
2	Transformer calibrator	HEF-H	#KI020 (YQ320)	2	2017.02.26

2.15.3 Reference standard requirement

The errors of the secondary winding(1a1n) shall meet the requirements of the accuracy class 0.2.

2.15.4 Data

Ambient temperature: 8°C Relative humidity : 68%

Secondary windings	Accuracy class	U _{pr} %	Ratio error (%)	Phase displacement (°)	Burden(VA) cosφ=0.8		Ratio error (%)	Phase displacement (°)	Burden(VA) cosφ=0.8	
					1a 1n	2a 2n			1a 1n	2a 2n
1a1n	0.2	80	-0.06	-4	100	50	+0.18	-1	25	0
		100	-0.08	-4			+0.16	-1		
		120	-0.14	-3			+0.10	0		

2.15.5 Test result

The test object passed the tests.

2.16 Electromagnetic Compatibility (EMC) tests (RIV test)

2.16.1 Test circuit diagram

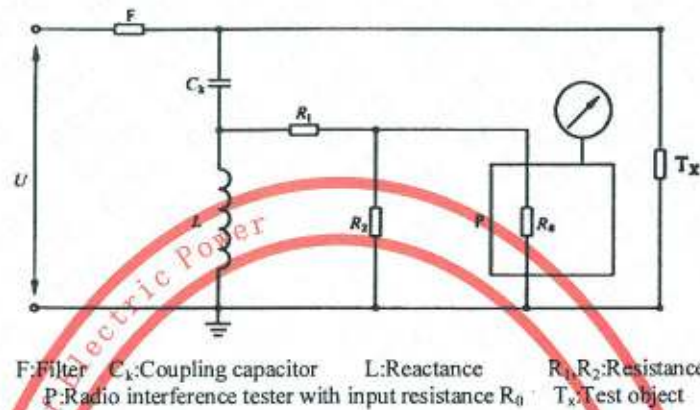

2.16.2 The main test device

No.	Name	Type/ Specification	Serial No.	Uncertainty / Accuracy class / Maximum Permissible Error	Valid date
1	Radio interference tester	ZN3950	#051205 (YQ392)	±2dB	2017.02.17
2	Power-frequency voltage measuring system	TJF1200-1000	#1105415 (YQ209-1)	3	2017.03.13

2.16.3 Reference standard requirement

A pre-stress voltage of $1.5U_m/\sqrt{3}$ shall be applied and maintained for 30s. The voltage shall then be decreased to $1.1U_m/\sqrt{3}$ in about 10s and maintained to this value for 30s before measuring the radio interference voltage. The radio interference voltage shall not exceed $2500\mu\text{V}$ at $1.1U_m/\sqrt{3}$.

2.16.4 Data

Ambient temperature:8℃ Relative humidity:72%

Test voltage (kV)	Tuning frequency of measuring circuit (MHz)	Radio interference voltage (μV)
160	0.5	<1210

2.16.5 Test result

The test object passed the tests.

2.17 Transmitted overvoltage test

2.17.1 The main test device

No.	Name	Type/ Specification	Serial No.	Uncertainty / Accuracy class / Maximum Permissible Error	Valid date
1	Ascilloscope	DPO4104	#C022104 (YQ302)	±3%	2017.02.03

2.17.2 Reference standard requirement

A low-voltage impulse (U_1) ($T_1=50 \mu s \pm 20\%$, $T_2 \geq 50 \mu s$) shall be applied between one of the primary terminals and earth. The transmitted overvoltage shall not exceed 1.6kV.

2.17.3 Data

Second winding	Type of impulse	Peak voltage of primary winding (U_1) (kV)	Peak voltage of secondary winding (U_2) (V)	Calculated transmitted overvoltage (U_s) (V)	Wave No.
1a1n	Type A impulse	121	90	245	1
2a2n	Type A impulse	120	90	247	2
dadn	Type A impulse	120	91	249	3

Note: $U_s = \frac{U_2}{U_1} \times U_p$ $U_p = 1.6 \frac{\sqrt{2}U_m}{\sqrt{3}}$

waveform

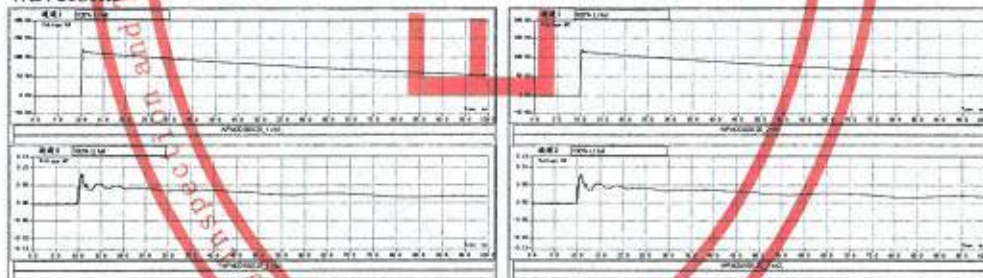

No.1

No.2

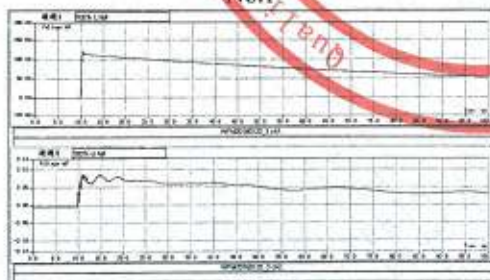

No.3

2.17.4 Test result

The test object passed the tests.

2.18 Mechanical tests

2.18.1 The main test device

No.	Name	Type/ Specification	Serial No.	Uncertainty / Accuracy class / Maximum Permissible Error	Valid date
1	Ergometer	XK3100-B1	#9119/C004 (YQ371)	1	2017.07.07

2.18.2 Reference standard requirement

The test load(1.5kN) shall be applied on primary terminal for at least 60s. There shall be no evidence of damage (deformation, rupture or leakage).

2.18.3 Data

Modality of application		Duration (s)	Test results
Horizontal(landscape orientation)	1500N	60	No evidence of damage (deformation, rupture or leakage) .
Horizontal(longitudinal orientation)	1500N	60	
Vertical	1500N	60	

2.18.4 Test result

The test object passed the tests.

2.19 Enclosure tightness test at ambient temperature

2.19.1 Test circuit diagram

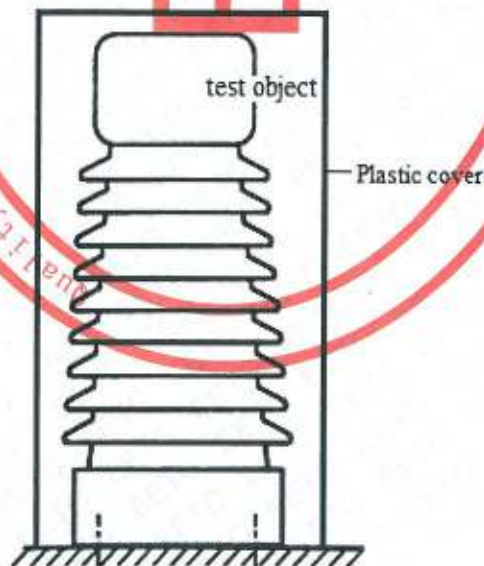

2.19.2 The main test device

No.	Name	Type/ Specification	Serial No.	Uncertainty / Accuracy class / Maximum Permissible Error	Valid date
1	SF ₆ gas detector	LF-I	#1984 (YQ334)	5%	2017.07.20

2.19.3 Reference standard requirement

The relative leakage rate (F_{rel}) shall not exceed 0.5% per year at rated filling pressure.

2.19.4 Data

Measuring volume $V_m(m^3)$	Gas chamber volume $V(m^3)$	Rated filling pressure P_r (MPa)	Tracer gas concentration C_1-C_0 (cm^3/m^3)	F_{rel} /year (%)
0.18	0.40	0.65	23	<0.1

2.19.5 Test result

The test object passed the tests.

2.20 Gas dew point test**2.20.1 The main test device**

No.	Name	Type/ Specification	Serial No.	Uncertainty / Accuracy class / Maximum Permissible Error	Valid date
1	Dew-point meter	DP99mini	#190171110 (YQ213)	$\pm 1^\circ C$	2017.07.19

2.20.2 Reference standard requirement

The dew-point is not higher than $-38.6^\circ C$ for a measurement at $20^\circ C$. The water content of gas shall be less than $150\mu L/L$.

2.20.3 Data

Dew-point at ambient temperature ($^\circ C$)	Dew-point at $20^\circ C$ ($^\circ C$)	The water content of SF ₆ ($20^\circ C$) $\mu L/L$
-46.6	-45.3	69

2.20.4 Test result

The test object passed the tests.

2.21 Verification of the degree of protection by enclosures

2.21.1 Test circuit diagram

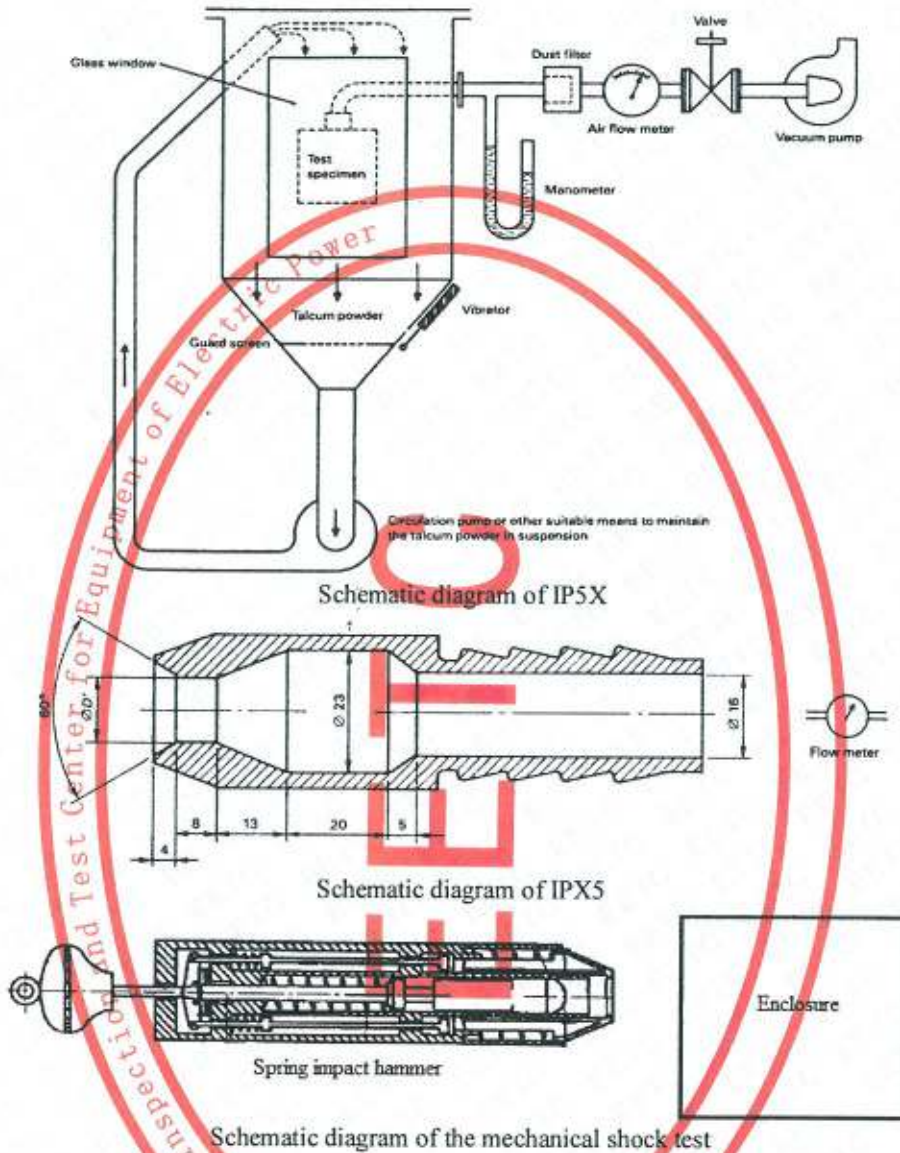

2.21.2 The main test device

No.	Name	Type/ Specification	Serial No.	Uncertainty / Accuracy class / Maximum Permissible Error	Valid date
1	Object probe	GR-F4D	GR15091204 (YQ213-5)	1.0 ^{+0.05} ₀ mm	2017.09.12
2	Dust chamber	SC-080	1508060 (SB221)	/	2016.10.22
3	Raining control system	JL-1-2	200912088 (SB326)	/	2017.05.06
4	Impact hammer	ZLT-CJ2	C021505 (YQ232)	1	2016.12.16

2.21.3 Reference standard requirement

Verification of the IP coding: The degree of protection of low-voltage control and /or auxiliary enclosures for outdoor instrument transformers is IP54.

Mechanical impact test: The level of protection against effects of mechanical impacts is impact level IK07.

2.21.4 Data

Verification of the IP coding: First characteristic Number of IP code: 5	
The test for protection against access to hazardous parts	The test for protection against solid foreign objects.
Test load: 1 N The test wire of 1.0mm Φ did not penetrate and kept adequate clearance .	Duration:8h Ingress of dust was not totally prevented, but the dust did not penetrate in a quantity to interfere with satisfactory operation of the apparatus or to impair safety.

Verification of the IP coding: Second characteristic Number of IP code: 4		
The test for protection against water		
Water flow (L/min)	Test pressure (kPa)	Duration (min)
10.5	101	5

Mechanical impact test (IK10):		
Standard kinetic energy (J)	Test kinetic energy (J)	Test times
20-0.10	2	3

2.21.5 Test result

The test object passed the tests.

2.22 Pressure test for the enclosure

2.22.1 Test circuit diagram

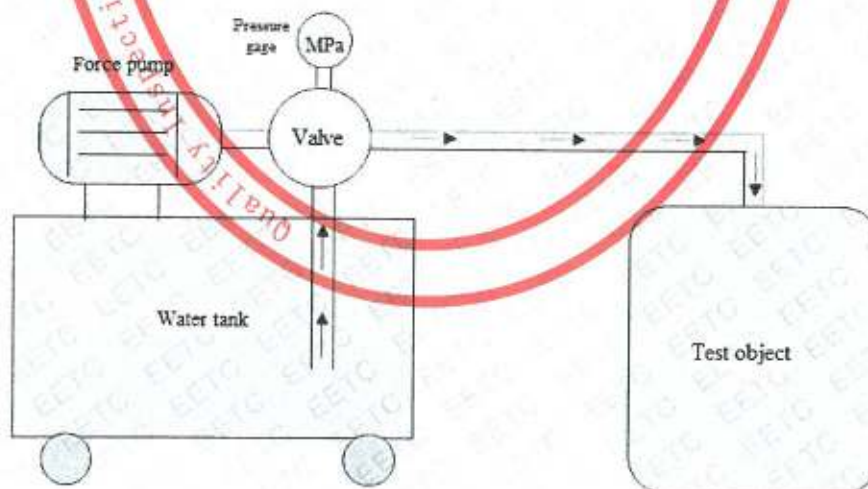

2.22.2 The main test device

No.	Name	Type/ Specification	Serial No.	Uncertainty / Accuracy class / Maximum Permissible Error	Valid date
1	Water pump for the test	4DSY-100/10	#201505012 (SB388)	/	2017.05.25
2	Pressure gage	YB-150A	#08.03.788 (BJ326)	0.4	2017.07.02

2.22.3 Reference standard requirement

Welded aluminum enclosure shall withstand $(3.5/0.7) \times$ "design pressure" for 1 min, no broken or permanent deformation.

Composite hollow insulators shall withstand $4.0 \times$ MSP for 5min, no visible damage occurred.

2.22.4 Data

Ambient temperature: 7°C Relative humidity : 72%

Texture	Test pressure (MPa)	Duration (min)
Welded aluminum	3.5	1
Composite hollow insulators	2.8	5

2.22.5 Test result

The test object passed the tests.

