

China Electric Power Research Institute
Quality Inspection and Test Center for Electric Equipment
of Power Industry



中国认可
国际互认
检测
TESTING
CNAS L0699

EETC2016HG302J

Test Report



Address: NO. 143, Luoyu Road, Hongshan District, Wuhan,
Hubei Province.

Postcode: 430074

Tel: 400-656-5689

Fax: 86-27-5937-8488

Website: <http://www.china-qitc.com.cn>

<http://www.epri.sgcc.com.cn>

NOTICE

- 1 This test report will enter into effect with exclusive test seals, a steel seal and anti-fake labels of EETC.
- 2 This report is legally made available accompany with tested, checked, verified and approved signatures.
- 3 Any objections in the report should be posed within 30 days once the report is received.
- 4 This report only takes responsibility to the test sample.
- 5 Report's authenticity can be confirmed via website or tel on the cover.

China Electric Power Research Institute
Quality Inspection and Test Center for Electric Equipment
of Power Industry
Test Report

EETC2016HG302J

1 Client

Guangdong SiHui Instrument Transformer Works Co.,Ltd

2 Sample Description

Name: Capacitor voltage transformer

Type: TYD220/ $\sqrt{3}$ -0.01H

Manufacturer: Guangdong SiHui Instrument Transformer Works Co.,Ltd

Manufacture Date: Nov., 2015

Sample No./Details: V1502220144

3 Standards/Specifications

GB20840.1-2010 Instrument transformers-Part 1: General requirements

GB/T20840.5-2013 Instrument transformers-Part5: Additional requirements for capacitor voltage transformers

IEC61869-1:2007 Instrument transformers-Part1: General requirements

IEC61869-5:2011 Instrument transformers-Part5: Additional requirements for capacitor voltage transformers

4 Test Category

Routine Test /Type Test/Special Test

5 Test Date

2016-01-05~2016-01-19

6 Conclusion

Capacitor voltage transformer with the type of TYD220/ $\sqrt{3}$ -0.01H offered by Guangdong SiHui Instrument Transformer Works Co.,Ltd meets the requirements of the corresponding items of the standard GB/T20840.5-2013, etc.

Note 1: In the event of any difference in meanings of the text, the Chinese report shall take priority over the English version.

Note 2: Period of validity: 5 years.

Tested by:



Checked by:



Verified by:

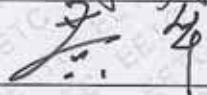

Approved by:

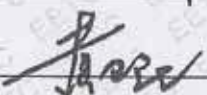

Date of issue:

2016-02-26

1 Summary of test results

No	Item	Requirement	Test results	Conclusion
1	Accuracy check	0.2/0.5 (3P) /3P	Details are shown in 2.1.4.	Pass
2	Temperature rise test	1.2 U _{pr} limit of the temperature rise of windings:60 K limit of the temperature rise of the oil at the top:50K	primary winding: 2K compensating reactor:2K 1a1n: 2K 2a2n: 2K top oil: 1K	Pass
		1.5 U _{pr} , 30 s, limit of the temperature rise of windings:70 K	primary winding: 3K compensating reactor: 3K 1a1n: 3K 2a2n: 3K dadn: 2K	
3	Capacitance and tan δ measurement at power frequency (preliminary)	Test voltage: $<0.15U_{pr}$ tan $\delta \leq 0.15\%$	Test voltage: $<0.15U_{pr}$ C ₂ : 84930pF, +0.081% C ₁ : 11341pF, +0.079% C _n : 10005pF, +0.081%	Pass
4	Electromagnetic compatibility test— Radio interference voltage measurement	Test Voltage:160kV RIV: $\leq 2500\mu V$	160kV $<1210\mu V$	Pass
5	Impulse voltage test on primary terminals— Light impulse voltage test on primary terminals	1050kV positive polarity: 15 times negative polarity: 15 times	1047kV~1058kV ± 15 times No puncture occurs.	Pass
	chopped impulse test	1208kV negative polarity:2 times	1211kV, 1201kV No puncture occurs.	Pass
6	Wet test for outdoor type transformers	In wet condition 460kV, 1min	460kV, 1min No puncture occurs.	Pass
7	Transient response test	3PT1	3PT1	Pass
8	Ferro-resonance test	0.8U _{pr} , 1.0U _{pr} , 1.2U _{pr} , 1.5U _{pr} each 10 times	0.8U _{pr} , 1.0U _{pr} , 1.2U _{pr} , 1.5U _{pr} each 10 times	Pass
9	Short circuit withstand capability test	Test voltage: 127kV Duration: 1 s	127kV, 1.01 s 1a1n Short-circuit current:212A	Pass
10	Accuracy test	0.2/0.5 (3P) /3P	Details are shown in 2.10.4 and 2.10.5.	Pass
11	Enclosure tightness test at ambient temperature	capacitor divider:60℃,8h	60℃, 8h	Pass
		electromagnetic unit:0.10MPa,8h Residual pressure ≥ 0.07 MPa	0.10MPa,8h Residual pressure 0.09MPa	

No	Item	Requirement	Test results	Conclusion
12	Capacitance and $\tan\delta$ measurement at power frequency (retest)	Test voltage: $<0.15U_{pr}$ $\tan\delta \leq 0.15\%$	Test voltage: $<0.15U_{pr}$ C_2 : 84929pF, +0.083% C_1 : 11341pF, +0.079% C_n : 10002pF, +0.082%	Pass
13	Power-frequency voltage withstand tests on primary terminals	Capacitor voltage divider		Pass
		Unit :242kV, 60s	242kV, 60s No puncture occurs.	
		Intermediate voltage terminal :57kV, 60s	57kV, 60s No puncture occurs.	
		Low voltage terminal:4 kV,60s	4kV, 60s No puncture occurs.	
		Electromagnetic unit		
		Intermediate voltage terminal of intermediate transformer: 57kV,150Hz,40s	57kV,150Hz,40s No puncture occurs.	
	Low voltage terminal of intermediate transformer : 4kV,60s	4kV, 60s No puncture occurs.		
	Compensating reactor: 10kV,150Hz,40s	10kV, 150Hz,40s No puncture occurs.		
14	Partial discharge measurement	Test voltage:132.3kV Permissible PD level: $\leq 10\text{pC}$	133kV C_{11} : 7pC, C_D : 7pC	Pass
		Test voltage:91.7kV Permissible PD level: $\leq 5\text{pC}$	92kV C_{11} : 2pC, C_D : 2pC	
15	Capacitance and $\tan\delta$ measurement at power frequency (final)	Test voltage: $(0.9\sim 1.1)U_{pr}$ $\tan\delta \leq 0.15\%$	Test voltage: $(0.9\sim 1.1)U_{pr}$ C_2 : 84905pF, +0.086% C_1 : 11336pF, +0.088% C_n : 9995pF, +0.090%	Pass
16	Verification of terminal markings	The nameplate and the mark of terminals shall meet the requirements.	Meet the requirements.	Pass
17	Power-frequency voltage withstand tests on secondary terminals	3kV,1min	3kV, 1min	Pass
18	Ferro-resonance check	$0.8U_{pr}$, $1.5U_{pr}$ each 3 times	$0.8U_{pr}$, $1.5U_{pr}$ each 3 times	Pass
19	Accuracy check (retest)	0.2/0.5 (3P) /3P	Details are shown in 2.19.4.	Pass
20	Performance test of dielectric oil in electromagnetic unit	Breakdown voltage ≥ 35 kV $\tan\delta (90^\circ\text{C}) \leq 1.0\%$	69.0kV +0.29%	Pass

No	Item	Requirement	Test results	Conclusion
21	Transmitted overvoltage test	$\leq 1.6\text{kV}$	573V~1157V	Pass
22	Mechanical tests	1250N, 1min	1250N, 1min	Pass
23	Verification of the degree of protection by enclosures	The degree of protection of low-voltage control and/or auxiliary enclosures for outdoor instrument transformers is IP55. The level of protection against effects of mechanical impacts is impact level IK07.	The degree of protection of low-voltage control and/or auxiliary enclosures for outdoor instrument transformers meet IP55 requirement. The level of protection against effects of mechanical impacts meet IK07 requirement.	Pass

1 Identification of the tested object

1.1 Parameters

Name: Capacitor voltage transformer

Type: TYD220/ $\sqrt{3}$ -0.01H

Serial No.: V1502220144

Manufacturer: Guangdong SiHui Instrument Transformer Works Co.,Ltd

Date of Manufacture: 2015.11

Sampling way: offer by client

Main parameters provided by the manufacturer:

Highest voltage for equipment (U_m)	252kV	Rated primary voltage(U_{pr})	220/ $\sqrt{3}$ kV				
Intermediate voltage capacitor	84678pF	High voltage capacitor	11339pF				
Rated capacitance	10000pF	Rated frequency	50Hz				
Rated voltage of intermediate transformer	15kV	Pollution level	IV				
Temperature categories	-25°C/+40°C	Altitude	$\leq 1000\text{m}$				
Position of compensating reactor	Low voltage terminal	Damping device	Fast saturation				
Parallel element of compensating reactor	Lightning arrester	Protection element of compensating reactor	No				
Rated voltage ratio	220/ $\sqrt{3}$ /0.1/ $\sqrt{3}$ /0.1/ $\sqrt{3}$ /0.1 kV						
Rated insulation level	252/460/1050kV						
Secondary winding/Accuracy class	1a1n/0.2	2a2n/0.5 (3PT1)	dadn/3P				
Rated burden (VA) /Power factor	(2.5-100) /0.8	(2.5-100) /0.8	(2.5-100) /0.8				
Capacitor divider							
name	C_{11}	C_{12}	C_{13}	C_D	C_2	C_1	C_n
serial number	1412288	/	/	1412290	/	/	/
Rated capacitance	20000 pF	/	/	20000 pF	84678pF	11339pF	10000pF
Element Num.	85	/	/	85	20	150	170

1.2 Drawings

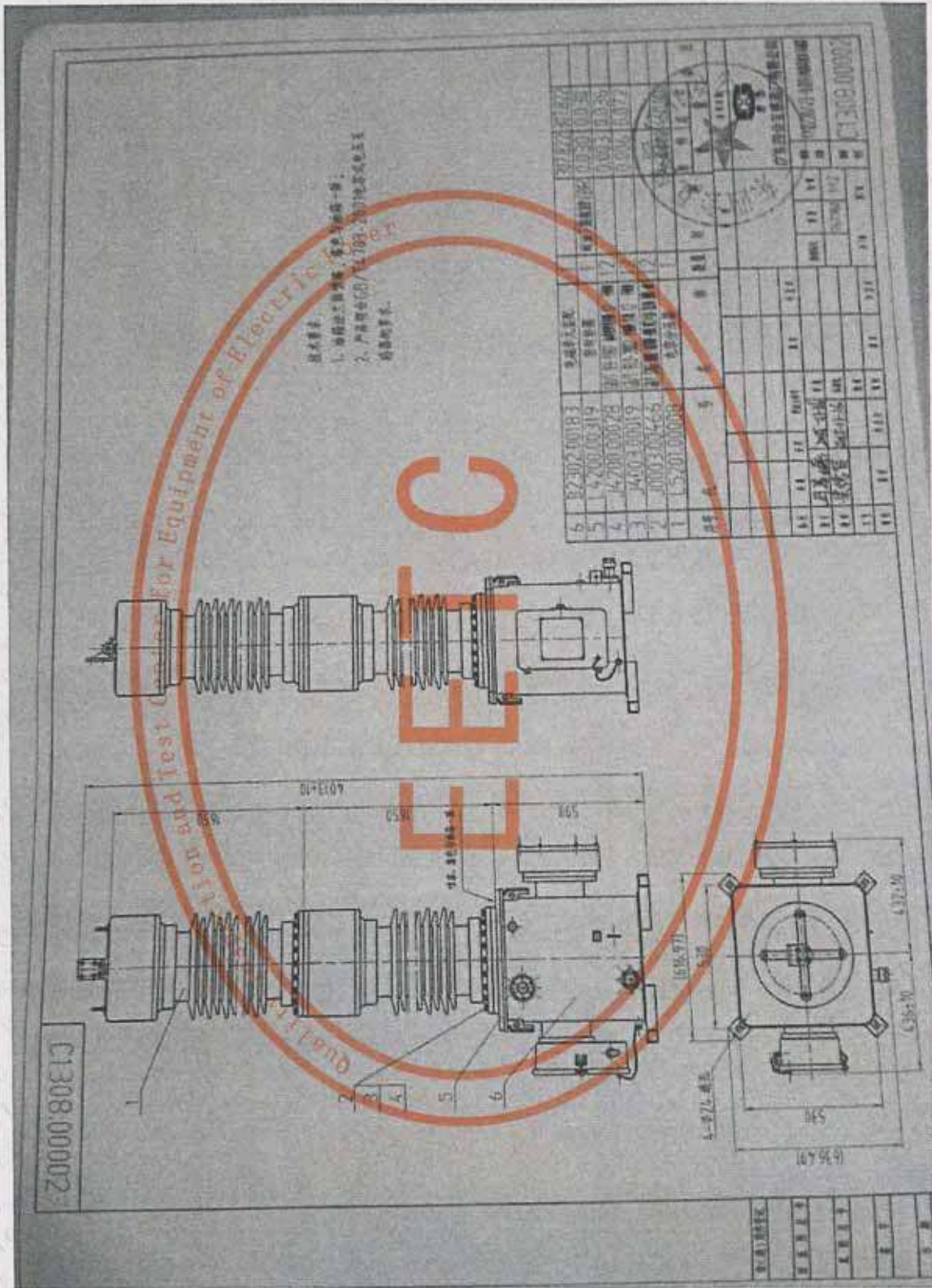

1.2.1 The testing laboratory has checked that the drawings and other data submitted by the client can adequately represent the essential details and parts of the equipment to be tested, but isn't responsible for the accuracy of the detailed information.

1.2.2 Before all the test, the tested object provided by the client is a new, clean capacitor voltage transformer, including ceramic bushing, frame, and all the other parts as in normal operation.

1.2.3 The test object is a capacitor voltage transformer that is comprised of a capacitor divider unit and an electromagnetic unit. The capacitor divider is comprised of two capacitor units with the line terminal on its top. The electromagnetic unit is comprised of an intermediate voltage transformer, a compensating reactor, and one or more damping devices. The creepage distance of the bushing is 8.85m, and the arcing distance is 2.88m.

1.2.4 Confirmed date of tested object: 2016-01-05

1.2.5 Authorized signature of Applicant: Lu Jianyi

1.3 Photograph of semblance



2 Test items and results

2.1 Accuracy check (begin)

2.1.1 Test circuit diagram

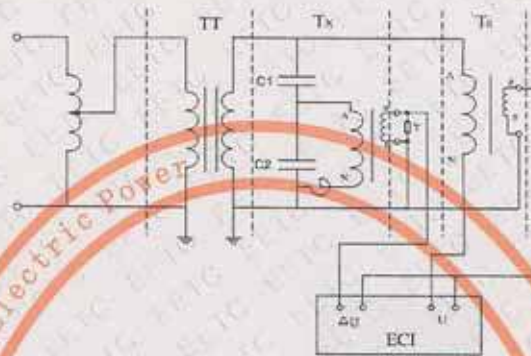

TT: testing transformer Tx: tested object T₀: standard voltage transformer ECI: test set

2.1.2 The main device used during the test

No.	Description	Type	Serial No.	Accuracy class/ Uncertainty	Valid date
1	Power-frequency test system	TRF1200-0.002	#111030 (YQ220)	3	2017-12-19
2	Resonance test transformer	YDGK-1200/3× 400	#111023 (SB220)	/	2016-01-26
3	Standard voltage transformer	HJ-220	#12006 (YQ367)	0.02	2016-10-27
4	Instrument transformer test set	HE20	#06104 (YQ319)	2	2016-11-14

2.1.3 Reference standard requirement

The errors of the secondary windings shall meet the requirements of the accuracy classes 0.2/0.5 (3P)/3P.

2.1.4 Data

Ambient temperature: 11°C Relative humidity: 74%

Secondary winding	Accuracy class	voltage $\frac{U}{U_{pr}}$ (%)	Burden (VA) /cosφ=0.8			Ratio error (%)	Phase displacement (′)	Frequency (Hz)
			1a1n	2a2n	dadn			
1a1n	0.2	100	100	100	0	-0.10	+5	50.0
			2.5	0	0	+0.16	+1	50.0
2a2n	0.5	100	100	100	0	-0.20	+2	50.0
			0	2.5	0	+0.15	0	50.0
2a2n	3P	5	100	100	0	-0.15	+4	50.0
			0	2.5	0	+0.20	+4	50.0
		150	100	100	100	-0.70	+2	50.0
			0	2.5	0	+0.20	+12	50.0
dadn	3P	5	100	100	0	-0.25	+2	50.0
			0	0	0	0	+2	50.0
		150	100	100	100	-1.20	+4	50.0
			0	0	2.5	-0.30	+12	50.0

2.1.5 Test result

The tested object was both in good condition before and after this test. This test has been passed.

2.1.6 Photograph of test site

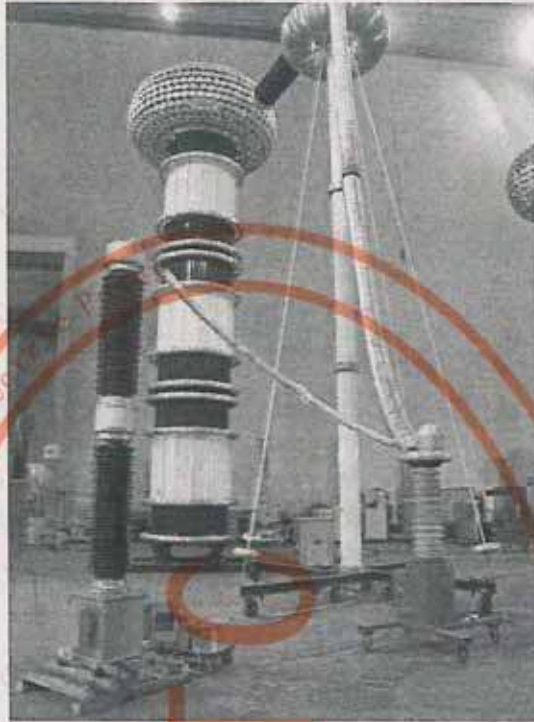

2.2 Temperature-rise test

2.2.1 Test circuit diagram

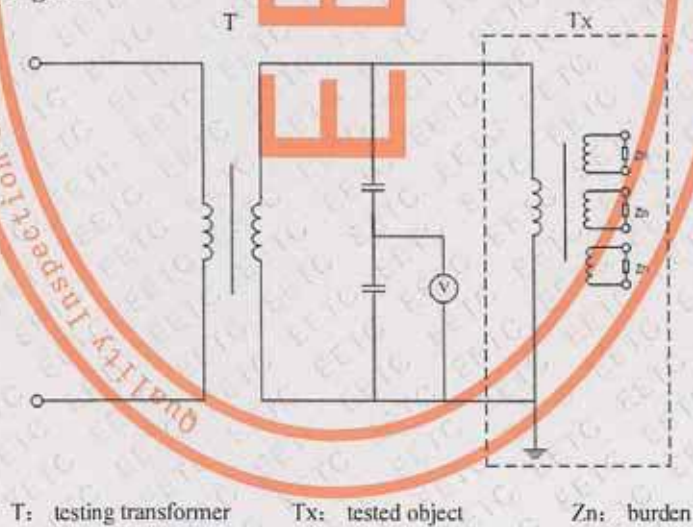

2.2.2 The main device used during the test

No.	Description	Type	Serial No.	Accuracy class/ Uncertainty	Valid date
1	DC bridge	JY44B	#01124972 (YQ210)	0.5	2016-01-25

2.2.3 Reference standard requirement

The test can be performed on the complete capacitor voltage transformer or on the electromagnetic unit alone. The test shall be performed in according with item below.

Performer temperature rise test on the tested object at 1.2 Upr, with the highest rated burden connected to each secondary winding except residual voltage winding. Measure the temperature rise until the transformer has reached a steady state.

Performer temperature rise test on the tested object at 1.5 Upr for 30s starting after the application of 1.2 Upr for a time sufficient to reach stable thermal conditions. And the residual voltage winding and other secondary windings shall connect to the highest rated burden.

The limit of the temperature rise as follows:

	1.2 Upr	1.5 Upr
The limit of windings (K)	60	70
The limit of top oil (K)	50	/

2.2.4 Data

The test was performed on the electromagnetic unit alone according to the reference standard requirement. The values of the temperature rise are shown as follow:

	AN	Compensating reactor	1a1n	2a2n	dadn	top oil	Ambient temperature
1.2 Upr	2K	2K	2K	2K	/	1K	10°C
1.5 Upr	3K	3K	3K	3K	2K	/	10°C

2.2.5 Test result

The tested object was both in good condition before and after this test. This test has been passed.

2.2.6 Photograph of test site

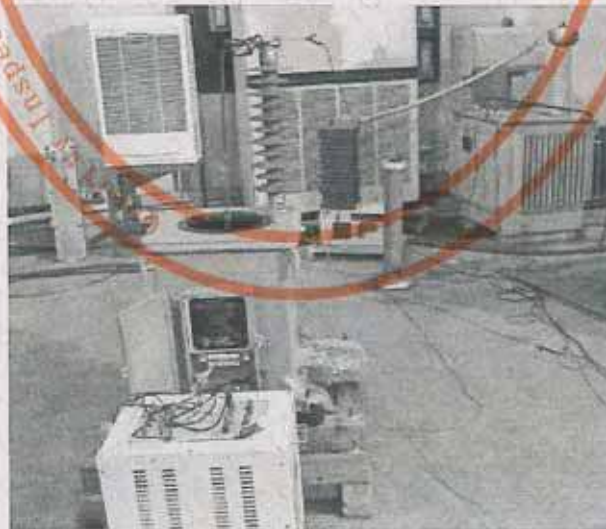

2.3 Capacitance and $\tan \delta$ measurement at power-frequency (preliminary)

2.3.1 Test circuit diagram

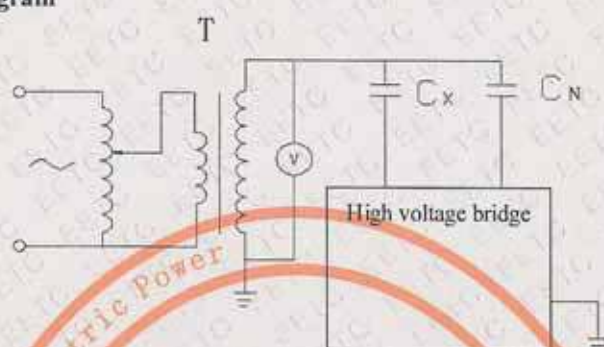

T: testing transformer Cx: tested object C_N: standard capacitance

2.3.2 The main device used during the test

No.	Description	Type	Serial No.	Accuracy class/ Uncertainty	Valid date
1	Standard capacitor	YL-200/100	#201214 (YQ328)	X: $\pm (0.05\% \times$ Reading $+0.01 \mu\text{F})$ D: 0.00001	2016-01-20
2	High voltage bridge	QS30	#031302Z (YQ404)	X: 0.001 D: 0.1	2017-06-04

2.3.3 Reference standard requirement

Measure the $\tan \delta$ and capacitance at the voltage less than 0.15 times rated voltage of the tested object before the dielectric type test.

2.3.4 Data

Ambient temperature: 10°C Relative humidity: 65%

Name	Test voltage (kV)	Capacitance (pF)	$\tan \delta$ (%)
C ₂	2	84930	+0.081
C ₁	17	11341	+0.079
C _n	19	10005	+0.081

2.3.5 Test result

The tested object was both in good condition before and after this test. This test has been passed.

2.3.6 Photograph of test site



2.4 Electromagnetic compatibility test—Radio interference voltage measurement

2.4.1 Test circuit diagram

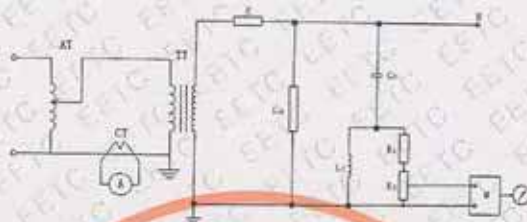

C: tested object M: measuring equipment Z: filter TT: testing transformer

2.4.2 The main device used during the test

No.	Description	Type	Serial No.	Accuracy class/ Uncertainty	Valid date
1	Radio interference test set	ZN3950	#051205 (YQ392)	±2dB	2016-01-28
2	Power-frequency testing transformer	TMZ17	#S3-9-36 (SB201)	/	2016-05-07
3	Power-frequency voltage divider	1500kV	#97-12-7 (YQ209)	3	2016-03-15

2.4.3 Reference standard requirement

A pre-stress voltage of $1.5 \times U_m / \sqrt{3}$ shall be applied and maintained for 30 s. The voltage shall then be decreased to $1.1 \times U_m / \sqrt{3}$ in about 10 s and maintained to this value for 30 s before measuring the radio interference voltage. The radio interference level at $1.1 \times U_m / \sqrt{3}$ shall not exceed $2500 \mu\text{V}$.

2.4.4 Data

Ambient temperature: 10°C Relative humidity: 65%

Test voltage (kV)	the radio interference level (0.5MHz) (μV)
160	<1210

2.4.5 Test result

The tested object was both in good condition before and after this test. This test has been passed.

2.4.6 Photograph of test site



2.5 Lightning impulse voltage test and chopped impulse test

2.5.1 Test circuit diagram

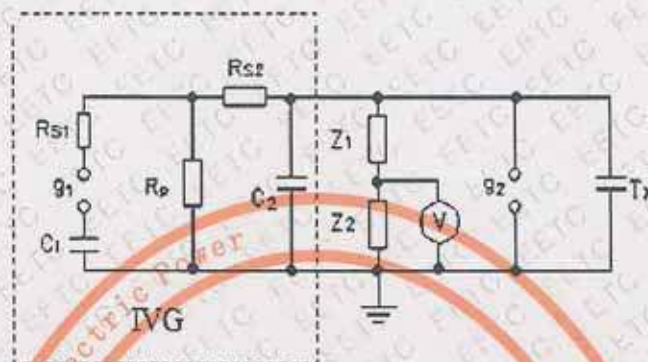

IVG: Impulse voltage generator Z_1, Z_2 : High voltage divider g_2 : Chopped device Tx: Tested object

2.5.2 The main device used during the test

No.	Description	Type	Serial No.	Accuracy class/ Uncertainty	Valid date
1	Impulse voltage generator	/	#17020001003 (SB202)	/	2016-05-07
2	Impulse voltage divider	/	#550264 (YQ212)	3	2017-08-05

2.5.3 Reference standard requirement

No disruptive discharge or more than 2 times flashovers occurs and no other evidence of insulation failure is detected.

	voltage (kV)	polarity	times
full lightning impulses	1050	+	15
full lightning impulses	1050	-	15
chopped lightning impulse	1208	-	2

2.5.4 Data

Ambient temperature: 10℃ Relative humidity: 65% Atmospheric pressure: 102.1 kPa

No.	Voltage polarity	Test voltage (peak)(kV)	Chopped time (after the peak) (μ s)	Waveform No.	Result
1	Pos.LI	571	/	1	Pass
2	Pos.LI	1048	/	2	Pass
3	Pos.LI	1047	/	3	Pass
4	Pos.LI	1048	/	4	Pass
5	Pos.LI	1048	/	5	Pass
6	Pos.LI	1048	/	6	Pass
7	Pos.LI	1048	/	7	Pass
8	Pos.LI	1048	/	8	Pass
9	Pos.LI	1047	/	9	Pass
10	Pos.LI	1057	/	10	Pass
11	Pos.LI	1056	/	11	Pass
12	Pos.LI	1057	/	12	Pass

No.	Voltage polarity	Test voltage (peak)(kV)	Chopped time (after the peak) (μs)	Waveform No.	Result
13	Pos.LI	1057	/	13	Pass
14	Pos.LI	1057	/	14	Pass
15	Pos.LI	1057	/	15	Pass
16	Pos.LI	1058	/	16	Pass
17	Neg.LI	571	/	17	Pass
18	Neg.LI	1052	/	18	Pass
19	Neg.LI-chopped	617	2.3	19	Pass
20	Neg.LI-chopped	1211	2.8	20	Pass
21	Neg.LI-chopped	1201	2.8	21	Pass
22	Neg.LI	1052	/	22	Pass
23	Neg.LI	1051	/	23	Pass
24	Neg.LI	1052	/	24	Pass
25	Neg.LI	1052	/	25	Pass
26	Neg.LI	1052	/	26	Pass
27	Neg.LI	1052	/	27	Pass
28	Neg.LI	1052	/	28	Pass
29	Neg.LI	1052	/	29	Pass
30	Neg.LI	1052	/	30	Pass
31	Neg.LI	1052	/	31	Pass
32	Neg.LI	1053	/	32	Pass
33	Neg.LI	1053	/	33	Pass
34	Neg.LI	1052	/	34	Pass
35	Neg.LI	1053	/	35	Pass

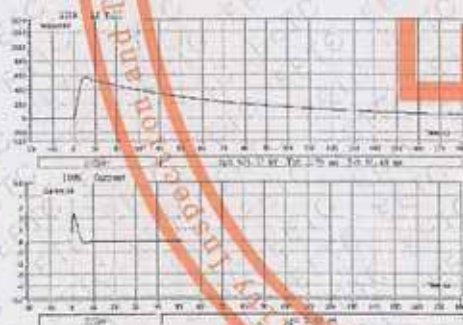

No.1



No.2



No.3

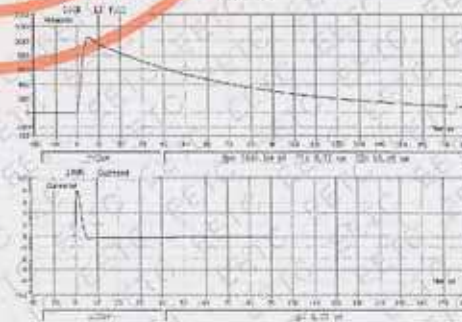

No.4



No.5

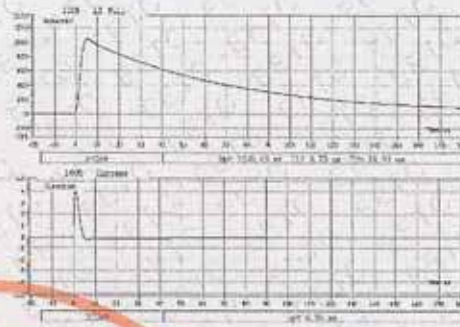

No.6

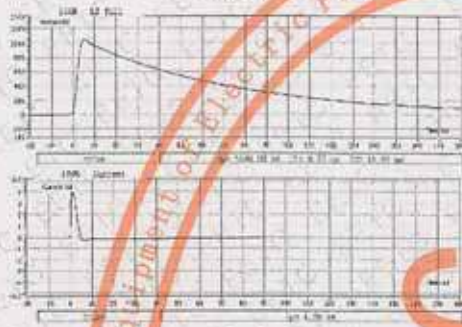

No.7

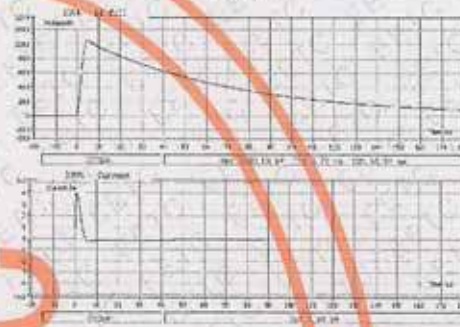

No.8

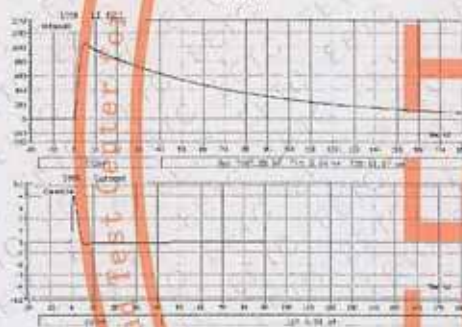

No.9

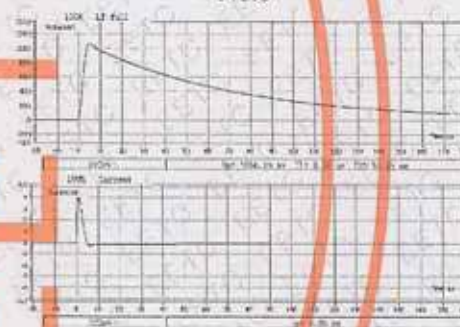

No.10

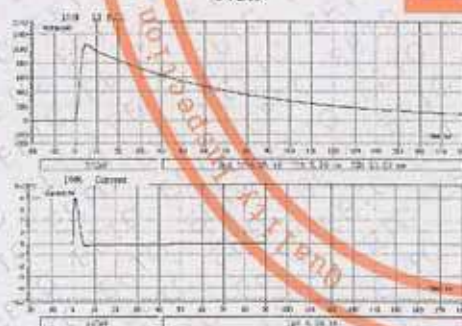

No.11

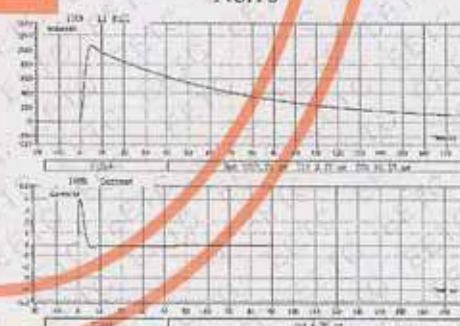

No.12

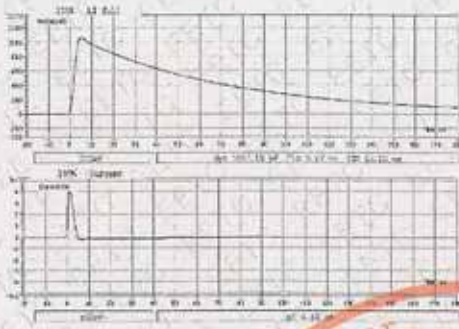

No.13

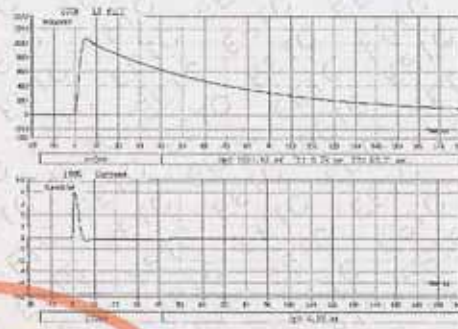

No.14

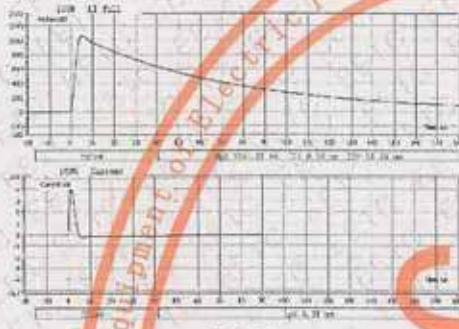

No.15

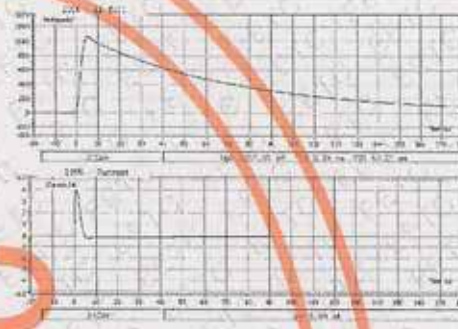

No.16

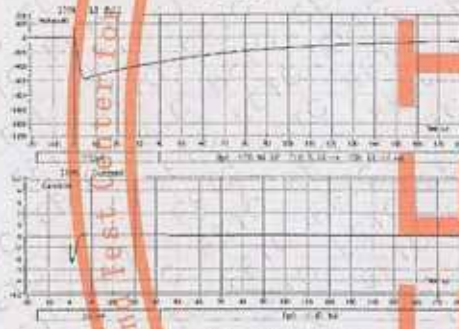

No.17

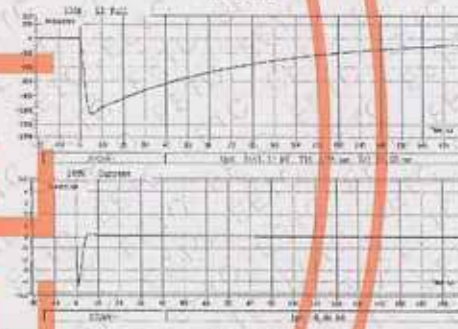

No.18

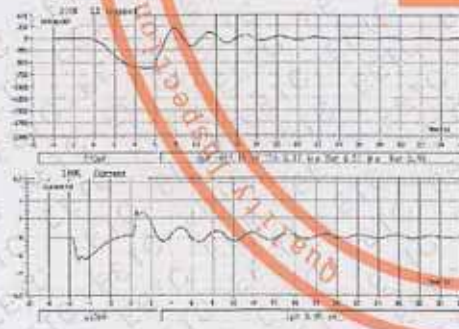

No.19

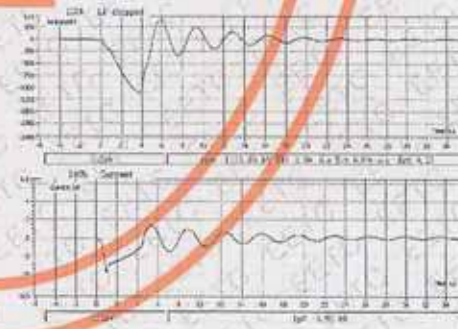

No.20

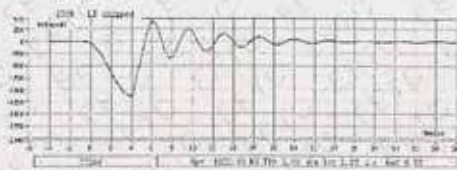

No.21

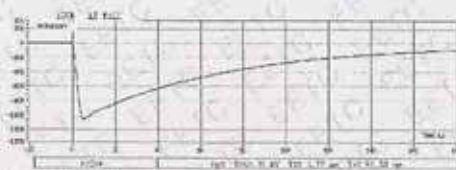
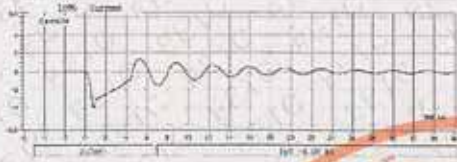

No.22

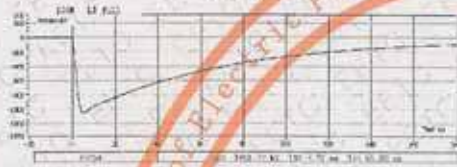

No.23

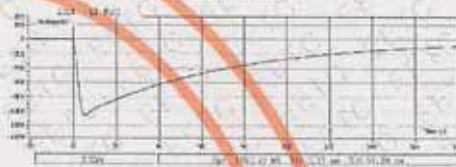

No.24

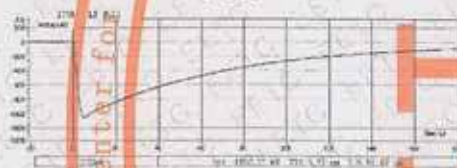

No.25

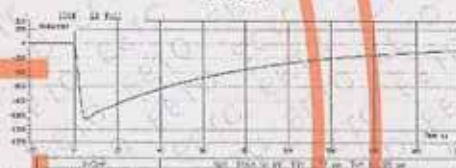

No.26



No.27



No.28



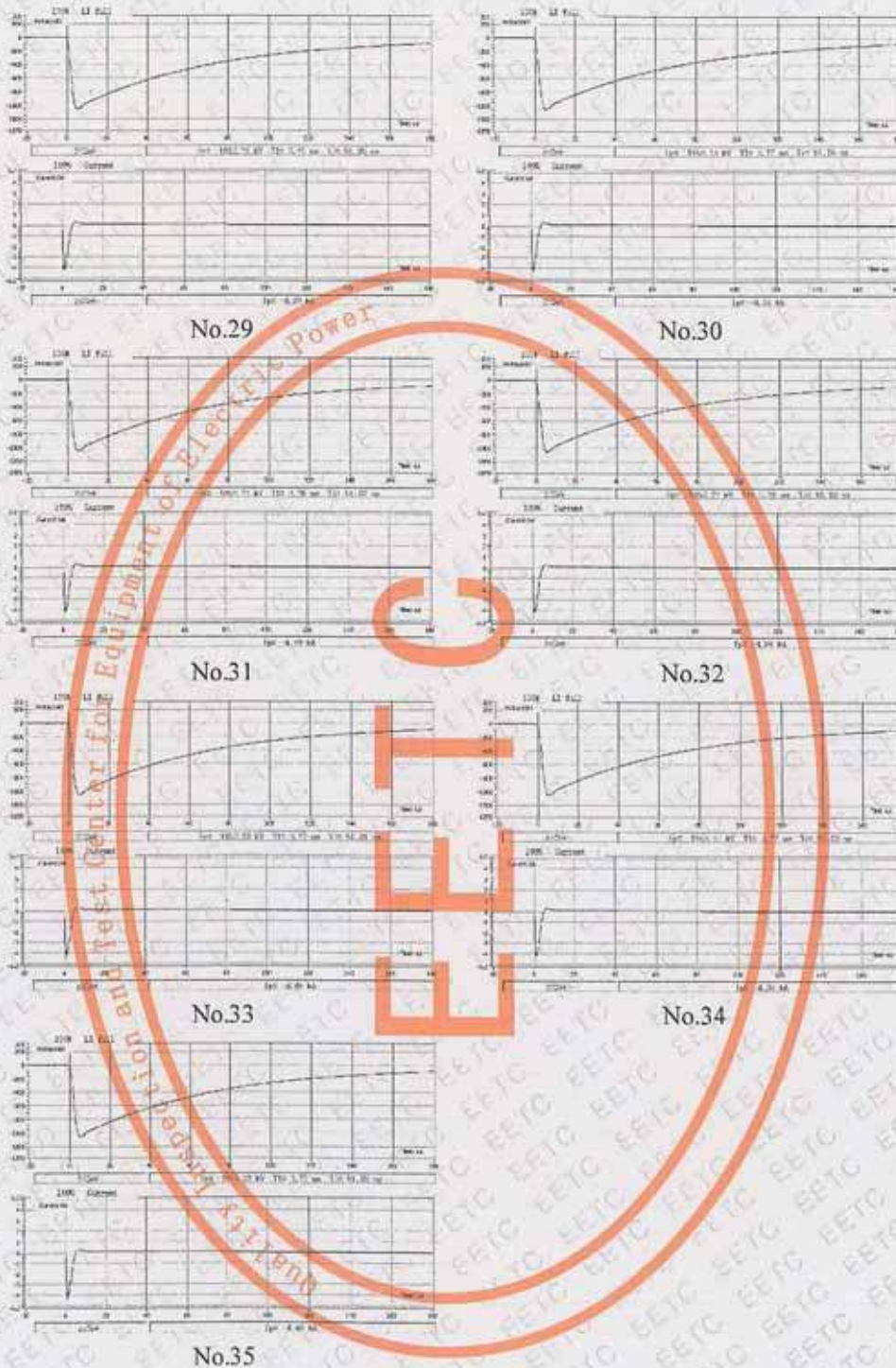

2.5.5 Test result

The tested object was both in good condition before and after this test. This test has been passed.

2.5.6 Photograph of test site

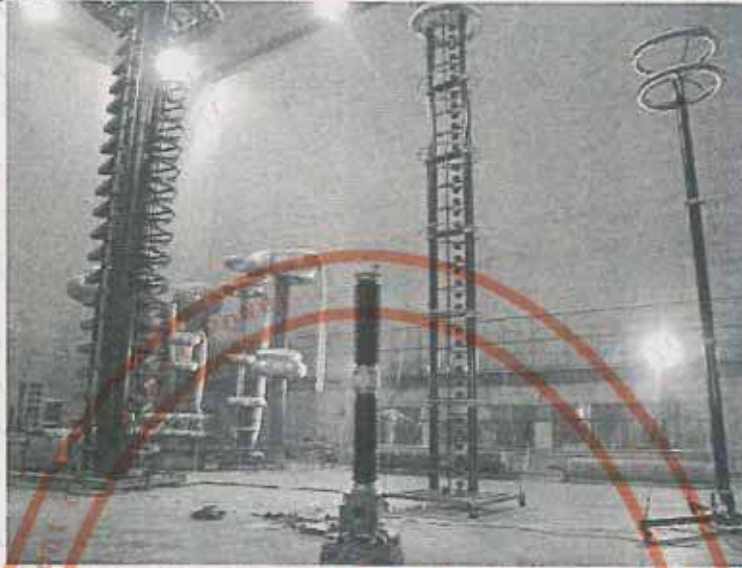

2.6 Wet test for outdoor type transformers

2.6.1 Test circuit diagram

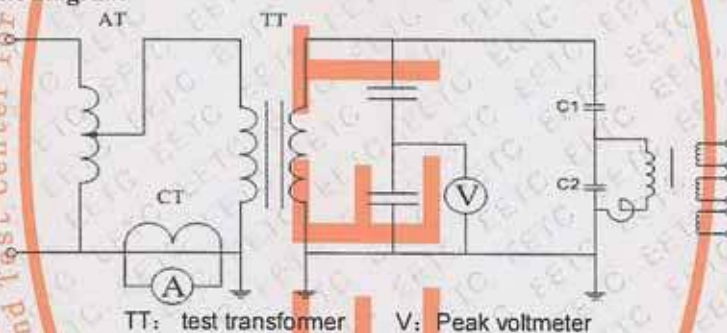

2.6.2 The main device used during the test

No.	Description	Type	Serial No.	Accuracy class/ Uncertainty	Valid date
1	Power-frequency testing transformer	TMZ17	#S3-9-36 (SB201)	1	2016-05-07
2	Power-frequency voltage divider	1500kV	#97-12-7 (YQ209)	3	2016-03-15

2.6.3 Reference standard requirement

In wet condition, the withstand voltage of 460kV shall be applied between the high voltage terminal and the earth for the duration of 1 min.

2.6.4 Data

Ambient temperature: 9°C Relative humidity: 72% Atmospheric pressure: 102.1 kPa

test voltage (kV)	460	duration (s)	60
rain conductivity ($\mu\text{s}/\text{cm}$)	110	water temperature ($^{\circ}\text{C}$)	7
Horizon (mm/min)	1.3	vertical (mm/min)	1.5
Atmospheric correction factor		$K_f=1.003$	

2.6.5 Test result

The tested object was both in good condition before and after this test. This test has been passed.

2.6.6 Photograph of test site



2.7 Transient response test

2.7.1 Test circuit diagram

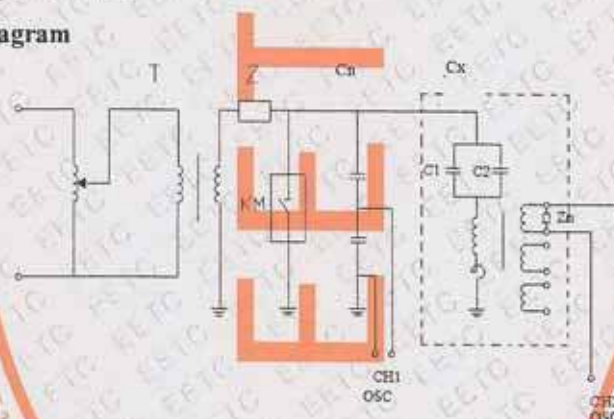

T: testing transformer KM: high-voltage grounding switch Cn: voltage divider
Cx: tested object OSC: oscilloscope

2.7.2 The main device used during the test

No.	Description	Type	Serial No.	Accuracy class/ Uncertainty	Valid date
1	Oscilloscope	DPO3014B	# Q2015008-45 (YQ405)	/	2016-02-01
2	Testing transformer	YDJ	#083112 (SB336)	/	2016-10-09

2.7.3 Reference standard requirement

The test shall be carried out only on the capacitor voltage transformer for protection purpose. The test shall be performed by short-circuiting the high voltage source in the equivalent circuit at $U_p \times C1 / (C1 + C2)$ at 100% and 0% of rated burden. The capacitor voltage transformer shall meet the requirements of the class 3PT1.

2.7.4 Data

2a2n
burden: 1a1n:100VA, 2a2n:100VA, dadn:100VA, Cosφ=1.0

Time	Waveform	Voltage ratio after 0.02 s (%)	Phase angle
1	100%-1	<10	peak
2	100%-2	<10	peak
3	100%-3	<10	zero
4	100%-4	<10	zero
5	120%-5	<10	peak
6	120%-6	<10	peak
7	120%-7	<10	zero
8	120%-8	<10	zero
9	150%-9	<10	peak
10	150%-10	<10	peak
11	150%-11	<10	zero
12	150%-12	<10	zero

2a2n
burden: 1a1n:0VA, 2a2n:0VA, dadn:0VA

Time	Waveform	Voltage ratio after 0.02 s (%)	Phase angle
1	100%-1	<10	peak
2	100%-2	<10	peak
3	100%-3	<10	zero
4	100%-4	<10	zero
5	120%-5	<10	peak
6	120%-6	<10	peak
7	120%-7	<10	zero
8	120%-8	<10	zero
9	150%-9	<10	peak
10	150%-10	<10	peak
11	150%-11	<10	zero
12	150%-12	<10	zero

typical waveform

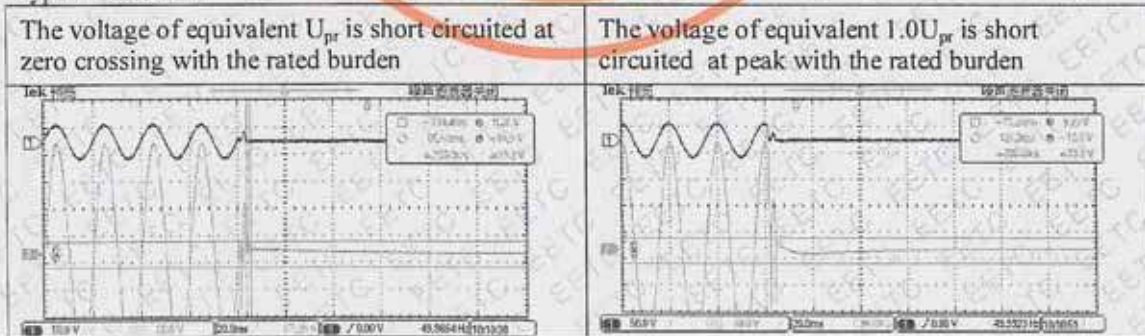

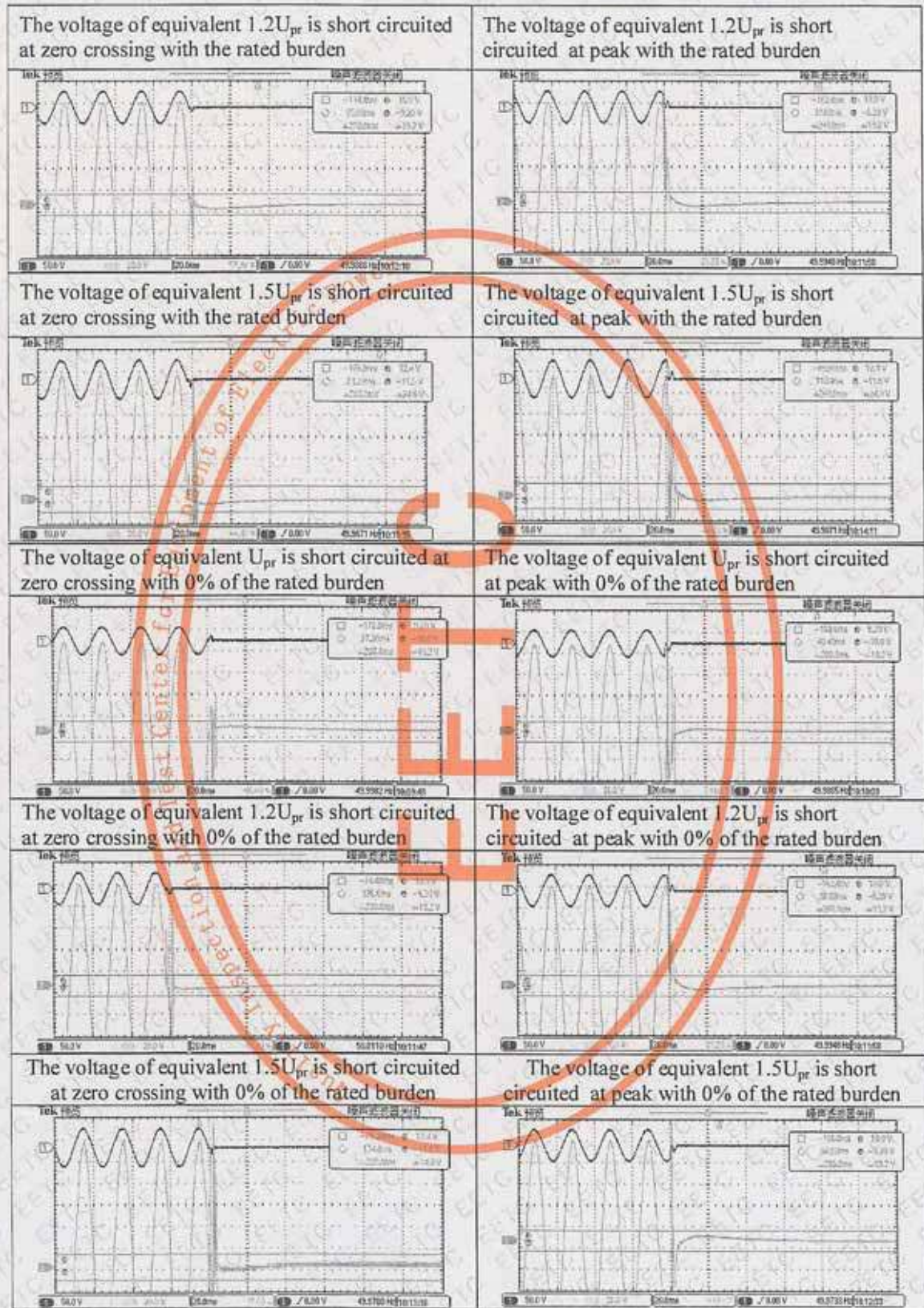

2.7.5 Test result

The tested object was both in good condition before and after this test. The capacitor voltage transformer could meet the requirements of the class 3PT1. This test has been passed.

2.7.6 Photograph of test site



2.8 Ferro-resonance test

2.8.1 Test circuit diagram

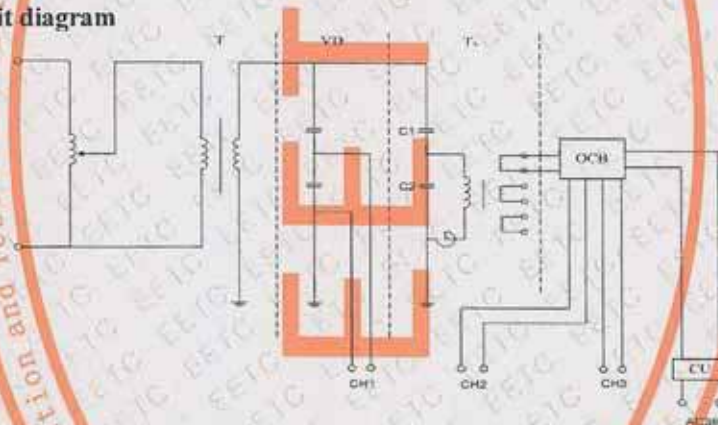

T: testing transformer OCB: test set VD: voltage divider Tx: tested object

2.8.2 The main device used during the test

No.	Description	Type	Serial No.	Accuracy class/ Uncertainty	Valid date
1	Power-frequency voltage divider	1500kV	#97-12-7 (YQ209)	3	2016-03-15
2	Power-frequency testing transformer	TMZ17	#S3-9-36 (SB201)	/	2016-05-07
3	Oscilloscope	DPO3014B	# Q2015008-45 (YQ405)	/	2016-02-01

2.8.3 Reference standard requirement

The burden of the secondary winding shall not exceed 1VA. Performing the tests for 10 times at the voltages of $0.8U_{pr}$, $1.0U_{pr}$, $1.2U_{pr}$, $1.5U_{pr}$ respectively. Short circuit the secondary winding at the voltages of $0.8U_{pr}$, $1.0U_{pr}$, $1.2U_{pr}$. The voltage of the secondary winding shall be recovered to the voltage that shall not differ by more than 10% from the voltage before the short-circuit within 0.5s. Short circuit the secondary winding at the voltages of $1.5U_{pr}$. The voltage of the secondary winding shall be recovered to the voltage that shall not differ by more than 10% from the voltage before the short-circuit within 2s.

2.8.4 Data

Primary voltage	Time	Waveform	Short-circuit time(cycle)	Recover time(cycle)
0.8 U_{pr}	1	1	6	7
	2	2	6	4
	3	3	6	7
	4	4	6	7
	5	5	6	3
	6	6	6	2
	7	7	6	1
	8	8	6	2
	9	9	6	1
	10	10	6	4
1.0 U_{pr}	1	11	6	5
	2	12	6	2
	3	13	6	2
	4	14	6	4
	5	15	6	5
	6	16	6	4
	7	17	6	5
	8	18	6	5
	9	19	6	5
	10	20	6	5
1.2 U_{pr}	1	21	6	3
	2	22	6	4
	3	23	6	3
	4	24	6	3
	5	25	6	4
	6	26	6	2
	7	27	6	2
	8	28	6	2
	9	29	6	2
	10	30	6	2
1.5 U_{pr}	1	31	6	2
	2	32	6	3
	3	33	6	2
	4	34	6	1
	5	35	6	1
	6	36	6	1
	7	37	6	1
	8	38	6	1
	9	39	6	1
	10	40	6	2

typical waveform

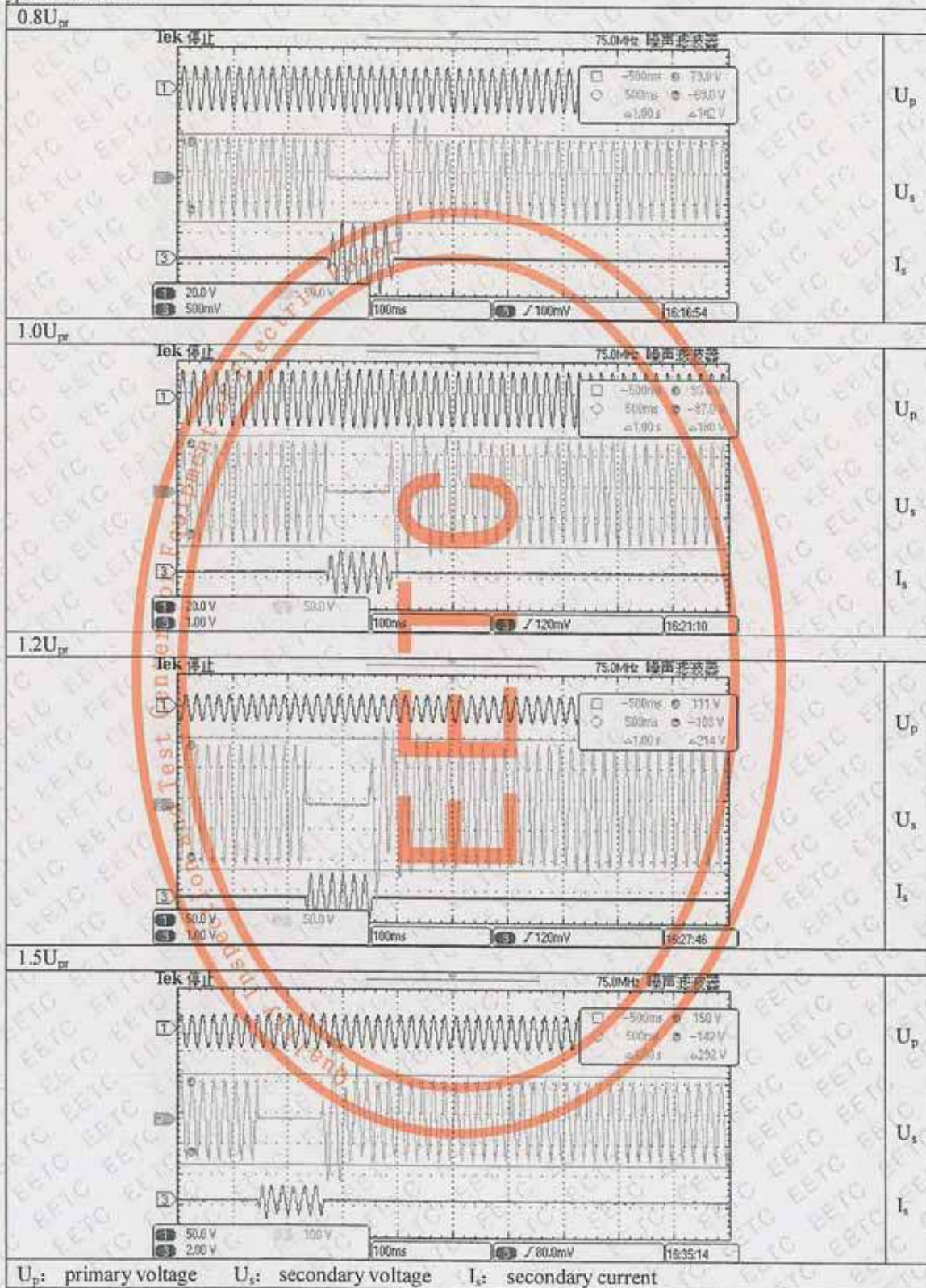

2.8.5 Test result

The tested object was both in good condition before and after this test. The test result could meet the requirements of reference standard. This test has been passed.

2.8.6 Photograph of test site



2.9 Short circuit withstand capability test

2.9.1 Test circuit diagram

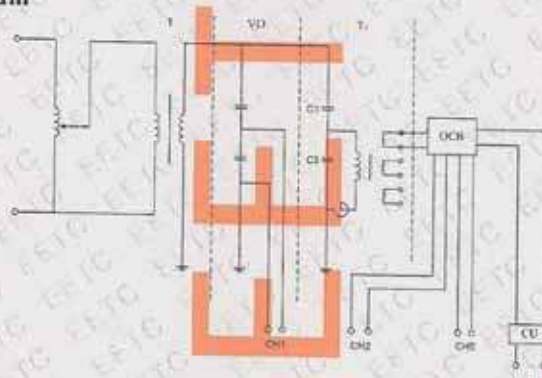

T: testing transformer OCB: test set VD: voltage divider Tx: tested object

2.9.2 The main device used during the test

No.	Description	Type	Serial No.	Accuracy class/ Uncertainty	Valid date
1	Power-frequency voltage divider	1500kV	#97-12-7 (YQ209)	3	2016-03-15
2	Power-frequency testing transformer	TMZ17	#S3-9-36 (SB201)	/	2016-05-07
3	Oscilloscope	DPO3014B	# Q2015008-45 (YQ405)	/	2016-02-01

2.9.3 Reference standard requirement

The r.m.s. value of the applied voltage at the transformer terminals shall be the rated primary voltage between phase and earth. The short-circuit applied between the secondary winding for the duration of 1 s. The capacitor voltage transformer shall be deemed to have passed this test if it satisfies the following requirements: ①it is not visibly damaged; ②its errors do not differ from those recorded before the tests by more than half the limits of error in its accuracy class; ③there is no significant change in the value of the capacitance; ④it can withstand the routine dielectric test; ⑤on examination, the insulation next to the surface of both primary and secondary windings of the e.m.u. does not show significant deterioration (this examination is not required if the current density in the winding does not exceed 160A/mm² where the winding is of copper).

2.9.4 Data

Ambient temperature: 9°C Relative humidity: 72%

Short-circuit secondary winding	Primary voltage (kV)	Secondary short-circuit current (A)	Duration (s)
1a1n	127	212	1.01

Note: The ratio of the current transformer used to measure the secondary short-circuit current is 300/5A. The value of the sampling resistance of the secondary short-circuit current is 0.10Ω.

	material	sectional area (mm ²)	Current density when the short-circuit occurred (A/mm ²)
The primary winding	copper	0.159	5.1
The secondary winding 1a1n	copper	24.4	8.7

Waveform of short-circuit test

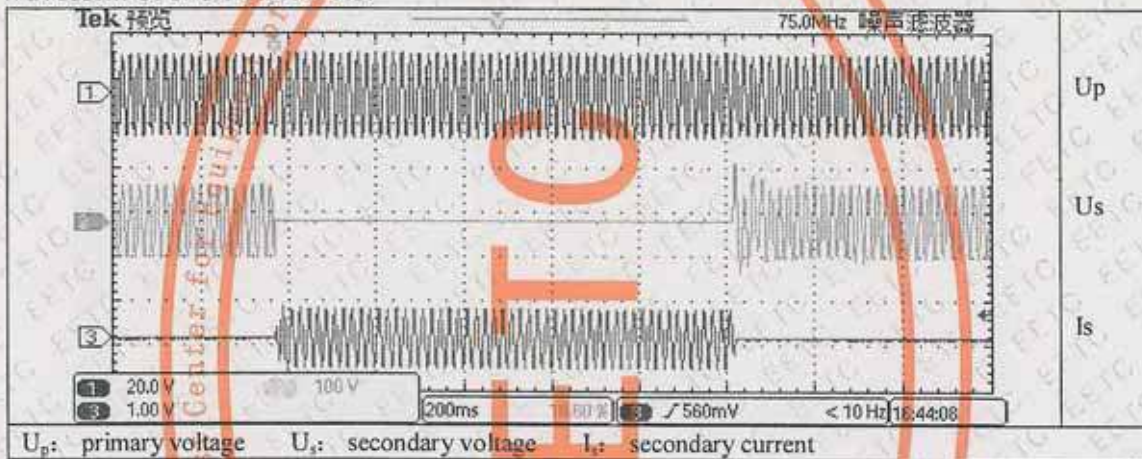

2.9.5 Test result

The tested object was both in good conditions before and after this test. The capacitor voltage transformer could meet the requirements of reference standard. This test has been passed.

2.9.6 Photograph of test site



2.10 Accuracy test

2.10.1 Test circuit diagram

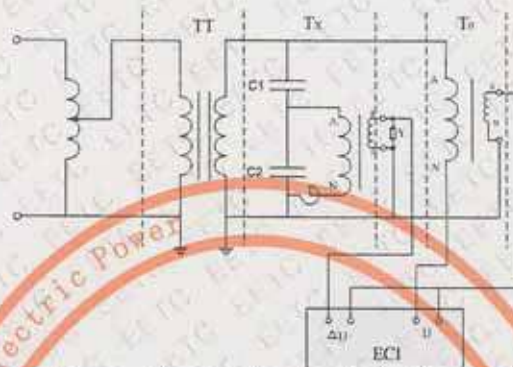

TT: testing transformer; Tx: tested object; Tr: standard voltage transformer; ECI: test set

2.10.2 The main device used during the test

No.	Description	Type	Serial No.	Accuracy class/ Uncertainty	Valid date
1	Power-frequency test system	TRF1200-0.002	#111030 (YQ220)	3	2017-12-19
2	Resonance test transformer	YDGK-1200/3 × 400	#111023 (SB220)	/	2016-01-26
3	Standard voltage transformer	HJ-220	#12006 (YQ367)	0.02	2016-10-27
4	Instrument transformer test set	HE20	#06104 (YQ319)	2	2016-11-14

2.10.3 Reference standard requirement

The errors of the secondary windings shall meet the requirements of the accuracy classes 0.2/0.5 (3P) /3P.

2.10.4 Data

Ambient temperature: 8 °C Relative humidity: 65%

Secondary winding	Accuracy class	voltage $\frac{U}{U_{pr}}$ (%)	Burden (VA) /cosφ=0.8			Ratio error (%)	Phase displacement (′)	Frequency (Hz)
			1a 1n	2a 2n	da dn			
1a1n	0.2	80	100	100	0	-0.12	+6	50.0
			2.5	0	0	+0.12	+1	50.0
		100	100	100	0	-0.12	+5	50.0
			2.5	0	0	+0.14	+1	50.0
		120	100	100	0	-0.12	+5	50.0
			2.5	0	0	+0.14	+1	50.0
2a2n	0.5	80	100	100	0	-0.20	+2	50.0
			0	2.5	0	+0.15	0	50.0
		100	100	100	0	-0.20	+2	50.0
			0	2.5	0	+0.15	0	50.0
		120	100	100	0	-0.20	+2	50.0
			0	2.5	0	+0.15	0	50.0

Secondary winding	Accuracy class	voltage $\frac{U}{U_{pr}}$ (%)	Burden (VA) / $\cos\phi=0.8$			Ratio error (%)	Phase displacement (')	Frequency (Hz)
			1a 1n	2a 2n	da dn			
2a2n	3P	2	100	100	0	-0.15	+6	50.0
			0	2.5	0	+0.15	+4	50.0
		5	100	100	0	-0.15	+4	50.0
			0	2.5	0	+0.15	+2	50.0
		100	100	100	0	-0.20	+2	50.0
			0	2.5	0	+0.15	0	50.0
150	100	100	100	-0.70	+2	50.0		
	0	2.5	0	+0.20	+10	50.0		
dadn	3P	2	100	100	0	-0.30	+4	50.0
			0	0	0	-0.05	+4	50.0
		5	100	100	0	-0.30	+2	50.0
			0	0	0	-0.05	+2	50.0
		100	100	100	0	-0.30	0	50.0
			0	0	0	-0.05	0	50.0
150	100	100	100	-1.20	+2	50.0		
	0	0	2.5	-0.35	+12	50.0		

2.10.5 The accuracy data under the room temperature and the limit frequency

Ambient temperature: 8°C Relative humidity: 65%

Secondary winding	Accuracy class	voltage $\frac{U}{U_{pr}}$ (%)	Burden (VA) / $\cos\phi=0.8$			Ratio error (%)	Phase displacement (')	Frequency (Hz)
			1a 1n	2a 2n	da dn			
1a1n	0.2	80	100	100	0	-0.10	+7	49.5
			2.5	0	0	+0.12	+1	49.5
		100	100	100	0	-0.10	+7	49.5
			2.5	0	0	+0.12	+1	49.5
		120	100	100	0	-0.10	+7	49.5
			2.5	0	0	+0.12	+1	49.5
1a1n	0.2	80	100	100	0	-0.14	+4	50.5
			2.5	0	0	+0.12	+1	50.5
		100	100	100	0	-0.14	+3	50.5
			2.5	0	0	+0.12	+1	50.5
		120	100	100	0	-0.14	+3	50.5
			2.5	0	0	+0.12	+1	50.5

2.10.6 The accuracy data under the limit temperature, the rated frequency and the limit frequency

Ambient temperature: -25°C

Secondary winding	Accuracy class	voltage $\frac{U}{U_{pr}}$ (%)	Burden (VA) / $\cos\phi=0.8$			Ratio error (%)	Phase displacement (')	Frequency (Hz)
			1a 1n	2a 2n	da dn			
1a1n	0.2	80	100	100	0	-0.12	+8	49.5
			2.5	0	0	+0.12	+1	49.5
		100	100	100	0	-0.12	+8	49.5
			2.5	0	0	+0.12	+1	49.5
		120	100	100	0	-0.12	+8	49.5
			2.5	0	0	+0.12	+1	49.5

Secondary winding	Accuracy class	voltage $\frac{U}{U_{pr}}$ (%)	Burden (VA) / $\cos\phi=0.8$			Ratio error (%)	Phase displacement (')	Frequency (Hz)
			1a 1n	2a 2n	da dn			
1a1n	0.2	80	100	100	0	-0.14	+6	50.0
			2.5	0	0	+0.12	+1	50.0
		100	100	100	0	-0.14	+6	50.0
			2.5	0	0	+0.12	+1	50.0
		120	100	100	0	-0.14	+6	50.0
			2.5	0	0	+0.12	+1	50.0
1a1n	0.2	80	100	100	0	-0.16	+4	50.5
			2.5	0	0	+0.12	+1	50.5
		100	100	100	0	-0.16	+4	50.5
			2.5	0	0	+0.12	+1	50.5
		120	100	100	0	-0.16	+4	50.5
			2.5	0	0	+0.12	+1	50.5

Ambient temperature: 40 °C

Secondary winding	Accuracy class	voltage $\frac{U}{U_{pr}}$ (%)	Burden (VA) / $\cos\phi=0.8$			Ratio error (%)	Phase displacement (')	Frequency (Hz)
			1a 1n	2a 2n	da dn			
1a1n	0.2	80	100	100	0	-0.14	+9	49.5
			2.5	0	0	+0.12	+1	49.5
		100	100	100	0	-0.14	+9	49.5
			2.5	0	0	+0.12	+1	49.5
		120	100	100	0	-0.12	+9	49.5
			2.5	0	0	+0.12	+1	49.5
1a1n	0.2	80	100	100	0	-0.16	+7	50.0
			2.5	0	0	+0.12	+1	50.0
		100	100	100	0	-0.16	+7	50.0
			2.5	0	0	+0.12	+1	50.0
		120	100	100	0	-0.14	+7	50.0
			2.5	0	0	+0.12	+1	50.0
1a1n	0.2	80	100	100	0	-0.18	+6	50.5
			2.5	0	0	+0.12	+1	50.5
		100	100	100	0	-0.18	+5	50.5
			2.5	0	0	+0.12	+1	50.5
		120	100	100	0	-0.16	+5	50.5
			2.5	0	0	+0.12	+1	50.5

2.10.7 Test result

The tested object was both in good condition before and after this test. The capacitor voltage transformer could meet the requirements of reference standard. This test has been passed.

2.10.8 Photograph of test site



2.11 Enclosure tightness test at ambient temperature

2.11.1 Tightness of the liquid-filled electromagnetic unit

2.11.1.1 The main device used during the test

No.	Description	Type	Serial No.	Accuracy class/ Uncertainty	Valid date
1	piezometer	Y-100	#115 (BJ324)	2.0	2016-12-18

2.11.1.2 Reference standard requirement

The interior pressure of the electromagnetic unit shall maintain 0.10MPa for the duration of 8h. The pressure remainder shall be not less than 0.07MPa. There shall be no evidence of leakage.

2.11.1.3 Data

The interior pressure of the electromagnetic unit maintained 0.10MPa for the duration of 8h. The pressure remainder is 0.09MPa. No evidence of leakage.

2.11.1.4 Test result

The tested object was both in good condition before and after this test. The capacitor voltage transformer could meet the requirements of reference standard. This test has been passed.

2.11.2 Tightness of the liquid-filled capacitor voltage divider

2.11.2.1 The main device used during the test

No.	Description	Type	Serial No.	Accuracy class/ Uncertainty	Valid date
1	Insulation incubator	BTT7128F	HA03-211185-2-1-III (SB386)	±3°C	2016-06-24

2.11.2.2 Reference standard requirement

The tightness test shall be done with a pressure of the liquid above the operating pressure for 8h. There shall be no evidence of leakage during the test.

2.11.2.3 Data

The capacitor is placed in air-oven where the ambient temperature is increased to 60°C, and maintained 8h. No leakage occurs.

2.11.2.4 Test result

The tested object was both in good condition before and after this test. The capacitor voltage transformer could meet the requirements of reference standard. This test has been passed.

2.12 Capacitance and $\tan \delta$ measurement at power-frequency (retest)

2.12.1 Test circuit diagram

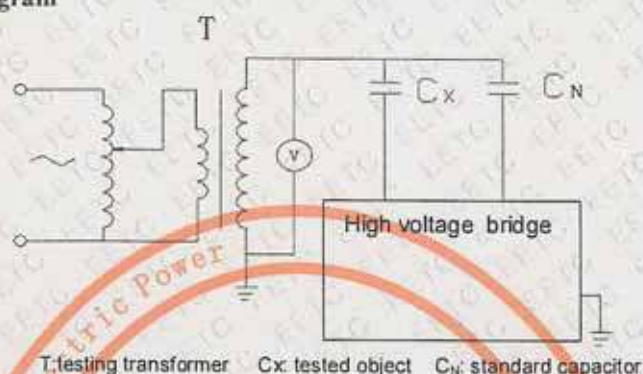

2.12.2 The main device used during the test

No.	Description	Type	Serial No.	Accuracy class/ Uncertainty	Valid date
1	Standard capacitor	YL-200/100	#201214 (YQ328)	X: $\pm (0.05\% \times$ Reading+0.01 pF) D: 0.00001	2016-01-20
2	High voltage bridge	QS30	#031302Z (YQ404)	X: 0.001 D: 0.1	2017-06-04

2.12.3 Reference standard requirement

Measure the $\tan \delta$ and capacitance at the voltage less than 0.15 times rated voltage of the tested object after the dielectric type test and before the dielectric routine test.

2.12.4 Data

Ambient temperature: 9℃ Relative humidity: 72%

Name	Test voltage (kV)	Capacitance (pF)	$\tan \delta$ (%)	Element number	Capacitance variation(%)	Whether puncture
C ₂	2	84929	+0.083	/	/	/
C ₁	17	11341	+0.079	/	/	/
C _n	19	10002	+0.082	170	-0.03	No

2.12.5 Test result

There is no puncture in capacitor divider of the tested object. This shows the dielectric type test before has been passed.

2.13 Power-frequency voltage withstand tests on primary terminals

2.13.1 The main device used during the test

No.	Description	Type	Serial No.	Accuracy class/ Uncertainty	Valid date
1	Power-frequency test system	TRF1200-0.002	#111030 (YQ220)	3	2017-12-19
2	Resonance test transformer	YDGK-1200/3×400	#111023 (SB220)	/	2016-01-26
3	equipment for voltage withstand tests	HZSY-S	#6120611 (SB210)	/	2016-10-08

2.13.2 Reference standard requirement

Parts	Test voltage (kV)	Frequency (Hz)	Duration (s)
between capacitor unit and earth	242	50	60
between the low voltage terminal of capacitor divider and earth	4	50	60
between the intermediate voltage terminal of capacitor divider and earth	57	50	60
between the intermediate voltage terminal of the intermediate transformer and earth	57	150	40
between the low voltage terminal of the primary winding of the intermediate transformer and earth	4	50	60
between the compensating reactor and earth	10	150	40

2.13.3 Data

Ambient temperature: 9°C Relative humidity: 72% Atmospheric pressure: 101.9 kPa

Parts	Atmospheric correction factor	Test voltage (kV)	Frequency (Hz)	Duration (s)
between capacitor unit and earth	0.9989	242	50	60
between the low voltage terminal of capacitor divider and earth	/	4	50	60
between the intermediate voltage terminal of capacitor divider and earth	/	57	50	60
between the intermediate voltage terminal of the intermediate transformer and earth	/	57	150	40
between the low voltage terminal of the primary winding of the intermediate transformer and earth	/	4	50	60
between the compensating reactor and earth	/	10	150	40

2.13.4 Test result

The tested object was both in good condition before and after this test. This test has been passed.

2.14 Partial discharge measurement**2.14.1 The main device used during the test**

No.	Description	Type	Serial No.	Accuracy class/ Uncertainty	Valid date
1	Partial discharge detector	JFD-2H	#20071203 (YQ380)	10	2016-03-01
2	Power-frequency test system	TRF1200-0.002	#111030 (YQ220)	3	2017-12-19
3	Resonance test transformer	YDGK-1200/3×400	#111023 (SB220)	/	2016-01-26

2.14.2 Reference standard requirement

Capacitor Unit or divider	Capacitor divider	C ₁₁	C ₁₂	C ₁₃	C ₁₄	C _D
Pre-stress voltage (kV)	/	242	/	/	/	242
Test voltage (kV)	/	132.3	/	/	/	132.3
Permission PD level (pC)	/	10	/	/	/	10
Test voltage (kV)	/	91.7	/	/	/	91.7
Permission PD level (pC)	/	5	/	/	/	5

2.14.3 Data

Ambient temperature: 9°C Relative humidity: 72%

Capacitor Unit or divider	Capacitor divider	C ₁₁	C ₁₂	C ₁₃	C ₁₄	C _D
Pre-stress voltage (kV)	/	242	/	/	/	242
Test voltage (kV)	/	133	/	/	/	133
PD level (pC)	/	7	/	/	/	7
Test voltage (kV)	/	92	/	/	/	92
PD level (pC)	/	2	/	/	/	2

2.14.4 Test result

The tested object was both in good condition before and after this test. The capacitor voltage transformer could meet the requirements of reference standard. This test has been passed.

2.15 Capacitance and $\tan \delta$ measurement at power-frequency (final)

2.15.1 test circuit diagram

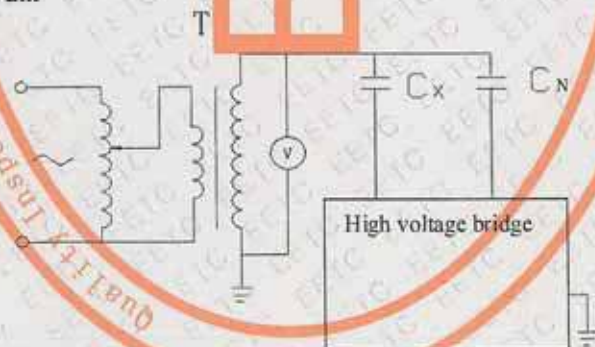

T: testing transformer Cx: tested object Cn: standard capacitor

2.15.2 The main device used during the test

No.	Description	Type	Serial No.	Accuracy class/ Uncertainty	Valid date
1	Standard capacitor	YL-200/100	#201214 (YQ328)	X: $\pm (0.05\% \times$ Reading + 0.01 pF) D: 0.00001	2016-01-20
2	High voltage bridge	QS30	#031302Z (YQ404)	X: 0.001 D: 0.1	2017-06-04

2.15.3 Reference standard requirement

First, measure the $\tan\delta$ and capacitance at the voltage less than 0.15 times rated voltage of the tested object after the dielectric routine test. The capacitance variation shall less than capacitance of the one element .Then carry out the final measurement at the voltage of $U_p \pm 10\%$. The capacitance tolerance between the measuring value and the rated value shall be less than -5% or +10%. The capacitor losses($\tan\delta$) shall be less than 5%.

2.15.4 Data

Ambient temperature: 9°C Relative humidity: 72%

Name	Test voltage (kV)	Capacitance (pF)	$\tan\delta$ (%)	Element number	Capacitance variation(%)	Whether puncture
C ₂	2	84910	+0.085	/	/	/
C ₁	17	11337	+0.089	/	/	/
C _n	19	9995	+0.090	170	-0.07	No

the final measurement

Ambient temperature: 9°C Relative humidity: 72%

Name	Test voltage (kV)	Capacitance (pF)	$\tan\delta$ (%)	Capacitance deviation from rated capacitance (%)
C ₁₁	63	20054	+0.067	+0.3
C _D	63	19969	+0.070	-0.2
C ₂	15	84905	+0.086	-0.3
C ₁	112	11336	+0.088	0
C _n	127	9995	+0.090	-0.1
The maximum deviation between the ratio of the capacitances of any two units forming part of a capacitor stack and the reciprocal ratio of the rated voltages of the units				0.4%

2.15.5 Test result

There is no puncture in capacitor divider of the tested object. This shows the dielectric test before has been passed. The capacitor voltage transformer could meet the requirements of reference standard. This test has been passed.

2.16 Verification of terminal markings

2.16.1 The main device used during the test

No.	Description	Type	Serial No.	Accuracy class/ Uncertainty	Valid date
1	Instrument transformer test set	HE20	#06104 (YQ319)	2	2016-11-14

2.16.2 Reference standard requirement

The nameplate and the mark of terminals shall meet the requirements.

2.16.3 Data

The nameplate, sign, earthing terminal, mark of terminals meet the requirements. The oil level indicator and the oil valve is entireness and in working-order. There is no evidence of leakage.

2.16.4 Test result

The capacitor voltage transformer could meet the requirements of reference standard. This test has been passed.

2.17 Power-frequency voltage withstand tests on secondary terminals

2.17.1 The main device used during the test

No.	Description	Type	Serial No.	Accuracy class/ Uncertainty	Valid date
1	Equipment for voltage withstand tests	HZSY-S	6120611 (SB210)	/	2016-10-08

2.17.2 Reference standard requirement

The test voltage of 3kV shall be applied for 60 s in turn between the short-circuited terminals of each winding and earth. There shall be no flashover and puncture occurs.

2.17.3 Data

The test voltage of 3kV was applied for 60 s in turn between the short-circuited terminals of each winding and earth. No flashover and puncture occurs.

2.17.4 Test result

The capacitor voltage transformer could meet the requirements of reference standard. This test has been passed.

2.18 Ferro-resonance check

2.18.1 The main device used during the test

No.	Description	Type	Serial No.	Accuracy class/ Uncertainty	Valid date
1	Power-frequency voltage divider	1500kV	#97-12-7 (YQ209)	3	2016-03-15
2	Power-frequency testing transformer	TMZ17	#S3-9-36 (SB201)	/	2016-05-07

2.18.2 Reference standard requirement

The burden of the secondary winding shall not exceed 1VA. Perform the tests for 3 times at the voltages of $0.8 U_{pr}$, $1.5 U_{pr}$ respectively. Short circuit the secondary winding at the voltage of $0.8 U_{pr}$. The voltage of the secondary winding shall be recovered to the voltage that shall not differ by more than 10% from the voltage before the short-circuit within 0.5s. Short circuit the secondary winding at the voltages of $1.5 U_{pr}$. The voltage of the secondary winding shall be recovered to the voltage that shall not differ by more than 10% from the voltage before the short-circuit within 2s.

2.18.3 Data

Primary voltage	Time	Short-circuit time(cycle)	Recover time(cycle)
$0.8 U_{pr}$	1	6	7
	2	6	7
	3	6	6
$1.5 U_{pr}$	4	6	3
	5	6	3
	6	6	2

2.18.4 Test result

The tested object was both in good condition before and after this test. The test result could meet the requirements of reference standard. This test has been passed.

2.19 Accuracy check

2.19.1 Test circuit diagram

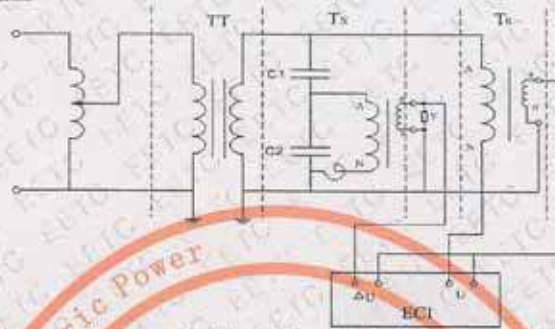

TT: testing transformer Tx: tested object T₀: standard voltage transformer ECI: test set

2.19.2 The main device used during the test

No.	Description	Type	Serial No.	Accuracy class/ Uncertainty	Valid date
1	Power-frequency test system	TRF1200-0.002	#111030 (YQ220)	3	2017-12-19
2	Resonance test transformer	YDGK-1200/3×400	#111023 (SB220)	/	2016-01-26
3	Standard voltage transformer	HJ-220	#12006 (YQ367)	0.02	2016-10-27
4	Instrument transformer test set	HE20	#06104 (YQ319)	2	2016-11-14

2.19.3 Reference standard requirement

The errors of the secondary windings shall meet the requirements of the accuracy classes 0.2/0.5 (3P) /3P.

2.19.4 Data

Ambient temperature: 8℃

Relative humidity: 62%

Secondary winding	Accuracy class	voltage $\frac{U}{U_{pr}}$ (%)	Burden (VA) $\frac{1}{\cos\phi}=0.8$			Ratio error (%)	Phase displacement (′)	Frequency (Hz)
			1a1n	2a2n	dadn			
1a1n	0.2	100	100	100	0	-0.14	+6	50.0
			2.5	0	0	+0.12	+1	50.0
2a2n	0.5	100	100	100	0	-0.20	+2	50.0
			0	2.5	0	+0.10	0	50.0
2a2n	3P	5	100	100	0	-0.15	+4	50.0
			0	2.5	0	+0.15	+2	50.0
		150	100	100	100	-0.60	+2	50.0
			0	2.5	0	+0.20	+12	50.0
dadn	3P	5	100	100	0	-0.30	+2	50.0
			0	0	0	-0.05	+2	50.0
		150	100	100	100	-1.05	+2	50.0
			0	0	2.5	-0.35	+14	50.0

2.19.5 Test result

The tested object was both in good condition before and after this test. This test has been passed.

2.20 Performance test of dielectric oil in electromagnetic unit

2.20.1 The main device used during the test

No.	Description	Type	Serial No.	Accuracy class/ Uncertainty	Valid date
1	tanδ measurement	XLDR-2000a	#081101 (YQ613)	C:2% D:0.01	2016-01-23
2	Dielectric strength measurement	XLNY/100	#261101 (YQ612)	5	2016-01-18

2.20.2 Reference standard requirement

The measurement of breakdown voltage and tanδ shall be performed on the dielectric oil. The value of breakdown voltage shall be no less than 35kV. And the value of tanδ(90℃) shall not exceed 1 %.

2.20.3 Data

The breakdown voltage of dielectric oil: 69.0kV.
The value of tanδ(90℃) of dielectric oil: +0.29%

2.20.4 Test result

The dielectric oil could meet the requirements of reference standard. This test has been passed.

2.21 Transmitted overvoltage test

2.21.1 The main device used during the test

No.	Description	Type	Serial No.	Accuracy class/ Uncertainty	Valid date
1	Impulse voltage divider system	TZF600-800	#2009 (YQ368)	3	2017-08-05

2.21.2 Reference standard requirement

Applying impulse-voltage between the primary terminal and earth, the overvoltage transmitted from the primary to the secondary windings shall be not exceed 1.6kV.

2.21.3 Data

Ambient temperature: 7℃ Relative humidity 63%

Secondary winding	Type of impulse	Peak voltage of primary winding (U ₁)(kV)	Peak voltage of secondary winding (U ₂)(V)	Calculated transmitted overvoltage (U _s)(V)	Wave No.
1a1n	Type A impulse	178	310	573	1
2a2n	Type A impulse	173	370	704	2
dadn	Type A impulse	182	640	1157	3

$$\text{Note: } U_s = \frac{U_2}{U_1} \times U_p \quad U_p = 1.6 \frac{\sqrt{2}U_m}{\sqrt{3}}$$

Waveform:

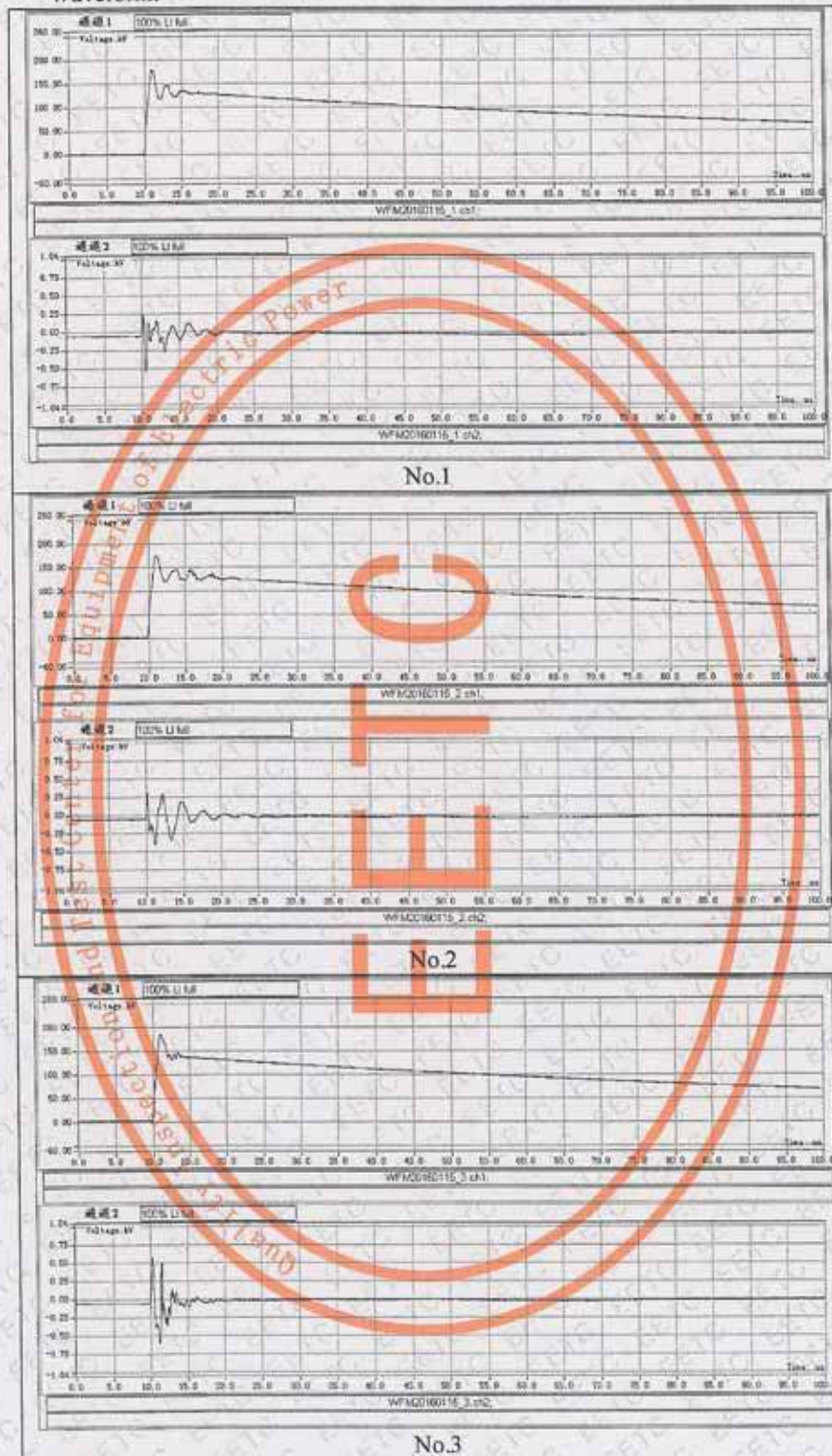

2.21.4 Test result

The tested object was both in good condition before and after this test. The capacitor voltage transformer could meet the requirements of reference standard. This test has been passed.

2.22 Mechanical tests

2.22.1 The main device used during the test

No.	Description	Type	Serial No.	Accuracy class/ Uncertainty	Valid date
1	Ergometer	XK3100-B1	#99119 (YQ371)	1	2016-07-07

2.22.2 Reference standard requirement

The capacitor voltage transformer shall be completely assembled and installed in vertical position with the frame rigidly fixed. The test loads be applied for 1250N, 1min for each of the condition. The capacitor voltage transformer shall be considered to have passed the test if there is no evidence of damage (deformation, rupture or leakage).

2.22.3 Data

Applied the test loads for 1250N, 1min along the horizontal direction and vertical direction. There was no evidence of damage (deformation, rupture or leakage).

2.22.4 Test result

The tested object was both in good conditions before and after this test. The capacitor voltage transformer could meet the requirements of reference standard. This test has been passed.

2.23 Verification of the degree of protection by enclosures

2.23.1 The main device used during the test

No.	Description	Type	Serial No.	Accuracy class/ Uncertainty	Valid date
1	Shell protective equipment	HP-50	#1050101086236 (YQ304)	1	2016-03-19
2	Spring impactor	SN3406	#08111320 (YQ339)	5	2016-12-11

2.23.2 Reference standard requirement

Verification of the IP coding: The degree of protection of low-voltage control and /or auxiliary enclosures for outdoor instrument transformers is IP55.

Mechanical impact test: The level of protection against effects of mechanical impacts is impact level IK07.

2.23.3 Data

Verification of the IP coding: First characteristic Number of IP code: 5		
The test for protection against access to hazardous parts	The test for protection against solid foreign objects.	
Test load: 1 N The test wire of 1.0mm Φ did not penetrate and kept adequate clearance.	Duration:8h Ingress of dust was not totally prevented, but the dust did not penetrate in a quantity to interfere with satisfactory operation of the apparatus or to impair safety.	
Verification of the IP coding: Second characteristic Number of IP code: 5		
The test for protection against water		
Water flow (L/min)	Test pressure (kPa)	Duration (min)
10.2	103	3
Mechanical impact test (IK07)		
Standard kinetic energy (J)	Test kinetic energy (J)	Test times
2.0 \pm 0.10	2.0	3

2.23.4 Test result

The tested object was both in good condition before and after this test. The capacitor voltage transformer could meet the requirements of reference standard. This test has been passed.